

CERSAIE 2017
NEW SERIES
YENİ SERİLER



seramiksan

Kurumsal

1994 yılında üretime başlayan Seramiksan, Türkiye'nin önde gelen Seramik üreticilerindendir ve Turgutlu / Manisa'da yer alan, İzmir limanına 45 km uzaklıktaki stratejik üretim konumu ile dünya genelinde 55 farklı ülkeye ihracat yapmaktadır.

Şirketimiz, 33 milyon m²'lik üretim kapasitesi ile portföyünde değişen ebatlarda ve tasarımda, yer ve duvar karosunun yanı sıra natural, lappato ya da full lappato yüzeyli porselen, sırsız porselen ve NANO teknoloji ile parlatılmış porselen bulundurmaktadır.

Seramiksan, sektördeki son teknolojik gelişmeleri yakından takip ederek Digiart teknolojisi ile üretilen yer ve duvar karoları ile de yaşam alanlarına farklılık katmaktadır.

1300 ürün, 18 farklı ebat, 50 farklı renk ve 250 farklı tasarım ile faaliyet gösteren firmamızın ana hedefi mevcut yatırımlarını ve üretim kapasitesini arttırarak yurtiçinde ve dışıda büyümeye devam etmektir.

Corporate

Seramiksan is one of the leading tile manufacturers of Turkey founded in 1994 in Turgutlu / Manisa, located in a strategic location 45 km away from Izmir port, exporting to 55 countries worldwide.

At present, our annual capacity is 33 million sqm consisting of various sizes and designs of wall and floor ceramic tiles, unglazed porcelain and "soluble-salt" tiles which are being polished with NANO technology, glazed porcelain tiles with natural, lappato and full lappato finish.

We follow the latest technological developments of our sector and running our production facilities with the recent innovations in ceramic industry. In our range, we have the wall and floor tile series called "Digiart" that distinguishes your living spaces by their design.

With a portfolio that includes 1300 products with 18 different sizes, 50 different colors, 250 different design; our main goal is to continue our growth in both domestic and export markets by new investments and by increasing our capacity with the production of new types of tiles.

Kuğu gibi estetik, Aesthetic and kuğu gibi uzun ömürlü. Longevous like a swan.

“Kuğular fiziksel görünüşleriyle zarafet ve asaletin sembolü haline gelmiş bir kuş türüdür. Tüylerinde bulunan yağ tabakası sayesinde suyun içinde ıslanmazlar. Ömürleri 100 - 150 yıldır.”

Üretim ve tasarım felsefemiz kuğulardan aldığımız ilhamla; her zaman fiziksel olarak en güzel, en zarif olanı en dayanıklı, en sağlam şekilde üretebilmek olmuştur.

“Swans are the sort of birds that have become the symbol of elegance and nobility owing to their physical appearance. They do not get wet in water because of the oily substance on their feathers. Their life time is between 100 and 150 years.”

Our manufacturing and designing philosophy is always to manufacture the most beautiful products which are physically strong and durable with the inspiration that we have from swans.

İçindekiler (Alfabetik) / Index (Alphabetical)

A	
Asia	24-25
B	
Belgium Stone	41
Belgium Stone (20 mm)	91
Bergama	12
Black Marble	8-9
Brecha	40
C	
Calacatta Marmi	28-29
Castelo	20-21
D	
Daintree	65
E	
Emperador	13
Ephesus	16-19
F	
Form	77
G	
Glossy	82
Granito	42-43
H	
Hardy	91
Hermes	92
İ	
İstanbul	48-49
K	
Kripton	44-45
L	
Leccino	15
Life	93
M	
Malmö	70-72
Matt	83
Metro	87
Milano	30-33
Monte Verde	60-61
N	
Nat. Black Marble	10-11
New Orleans	26-27
O	
Oslo	66-67
P	
Paradise	39
Parma Rosso	16-18
Perge	36-38
Philadelphia	34-35
Poudre	81
Q	
Quartzite	90
R	
Resolute	90
Riga	69
S	
Sabbia	80
Sagano	62-64
Serastep	52-57
Serena	84-86
Silver Calacatta	79
Stil	68
T	
Tivoli.....	22-23
V	
Venüs	46-47
Verde Alpi	14
Vista	68
W	
Wood Dream	73-76

İçindekiler / Index

Black Marble	8-9
Nat. Black Marble	10-11
Bergama	12
Emperador	13
Verde Alpi	14
Leccino	15
Parma Rosso	16-18
Ephesus	16-19
Castelo	20-21
Tivoli.....	22-23
Asia	24-25
New Orleans	26-27
Calacatta Marmi	28-29
Milano	30-33
Philadelphia	34-35
Perge	36-38
Paradise	39
Brecha	40
Belgium Stone	41
Granito	42-43
Kripton	44-45
Venüs	46-47
İstanbul	48-49
Serastep	52-57
Monte Verde	60-61
Sagano	62-64
Daintree	65
Oslo	66-67
Stil	68
Vista	68
Riga	69
Malmö	70-72
Wood Dream	73-76
Form	77
Silver Calacatta	79
Sabbia	80
Poudre	81
Glossy	82
Matt	83
Serena	84-86
Metro	87
Quartzite	90
Resolute	90
Hardy	91
Belgium Stone (20 mm)	91
Hermes	92
Life	93

Teknik Bilgiler ve Özellikleri

Technical Information & Characteristics

Semboller / Symbols..... 94

Teknik Bilgiler..... 95

Technical Information

Teknik Özellikler..... 96-97

Technical Characteristics

Paketleme Detayları..... 98

Packaging Details

Yapı Kimyasalları..... 99

Construction Chemicals

IŞILDAYAN MERMER ETKİSİ

IRIDESCENT MARBLE EFFECT

Seramiksan mermerin nadir güzelliğini seramiğin dayanıklılığı ile birleştiriyor. İç ve dış mekanlara rahatlıkla uygulanabilen Bella Marmi Serisi, farklı boyut seçenekleri ile yaşam alanlarınıza doğal bir dokunuş sunuyor.

Seramiksan combines the durability of ceramic with the beauty of rare marbles, for iridescent floor and wall coverings. Suitable to be practiced both indoor and outdoor with varying sizes, Bella Marmi Series provide a natural marble touch to living spaces.

Bella SERIES
Marmi



BLACK MARBLE



Sırlı Porselen Karo / Glazed Porcelain Tile

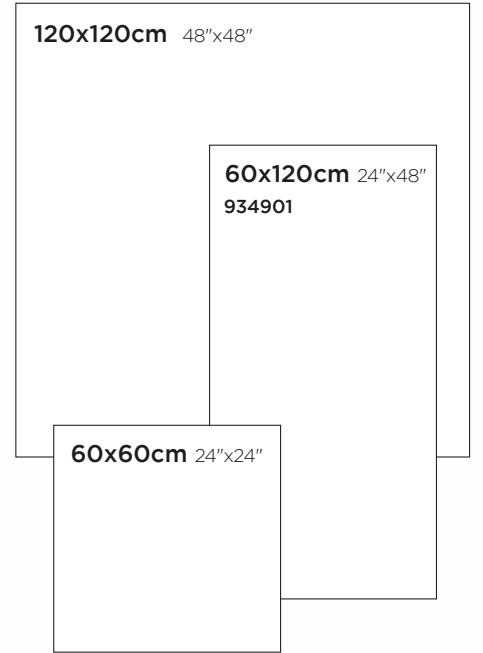

Ürün / Product	Ebat / Size (cm)	Birim / Unit (m ² /Ad/kg)	Kutu / Box			Palet / Pallet		
			(Ad-Pcs)	(m ²)	(kg)	(Kutu-Box)	(m ²)	(kg)
Porselen Karo / Porcelain Tiles	120x120	m ²	1	1,44	36,3	30	43,2	1,100
	60x120	m ²	2	1,44	36,3	29	41,76	1,080
	60x60	m ²	4	1,44	33	30	43,2	1,020





NAT. BLACK MARBLE



Porselen Karo / Porcelain Tile "UGL"



- TS-EN 14411 standardına göre aşınma < 175 mm³ değerine uygun olarak üretilir.
- Abrasion resistance value of porcelain tile is < 175 mm³ according to TS-EN 14411.

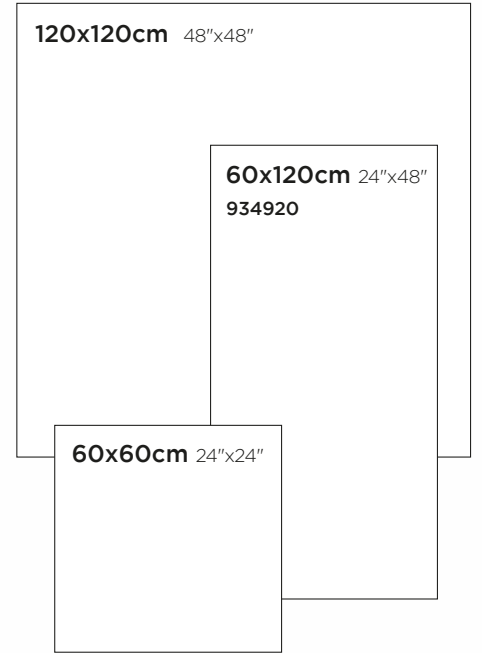

Ürün / Product	Ebat / Size (cm)	Birim / Unit (m ² /Ad/kg)	Kutu / Box			Palet / Pallet		
			(Ad-Pcs)	(m ²)	(kg)	(Kutu-Box)	(m ²)	(kg)
Porselen Karo / Porcelain Tiles	120x120	m ²	1	1,44	36,3	30	43,2	1,100
	60x120	m ²	2	1,44	36,3	29	41,76	1,080
	60x60	m ²	4	1,44	33	30	43,2	1,020

Nat. Black Marble



Nat. Black Marble, Calacatta Marmi /
Nat. Black Marble, Calacatta Marmi

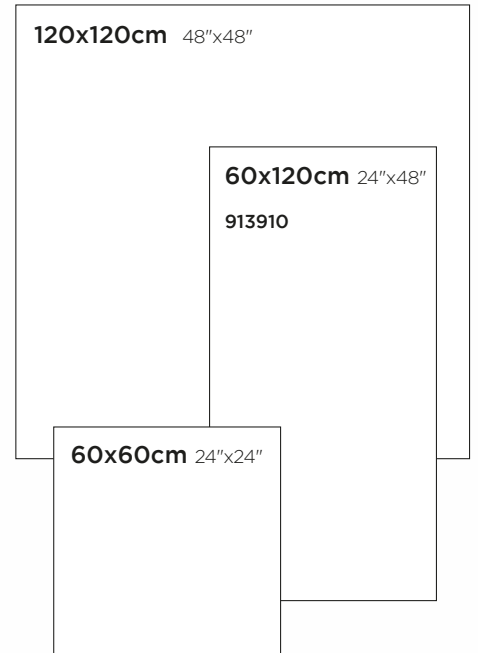

Ürün / Product	Ebat / Size (cm)	Birim / Unit (m ² /Ad/kg)	(Ad-Pcs)	Kutu / Box			Palet / Pallet		
				(m ²)	(kg)	(Kutu-Box)	(m ²)	(kg)	
Porselen Karo / Porcelain Tiles	120x120	m ²	1	1,44	36,3	30	43,2	1,100	
	60x120	m ²	2	1,44	36,3	29	41,76	1,080	
	60x60	m ²	4	1,44	33	30	43,2	1,020	



EMPERADOR Siyah / Black



Sırlı Porselen Karo / Glazed Porcelain Tile

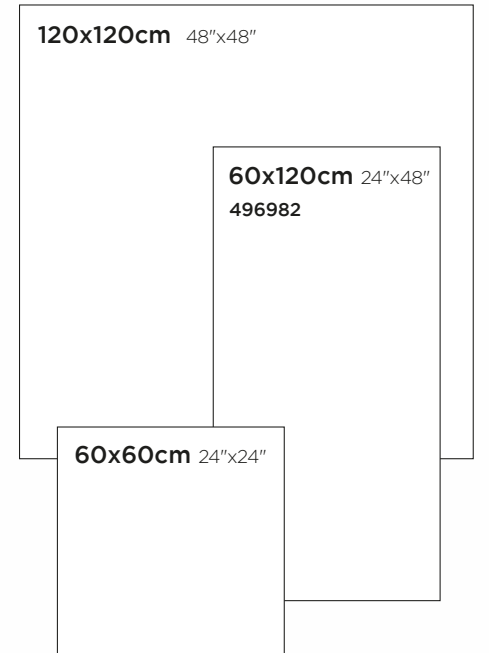
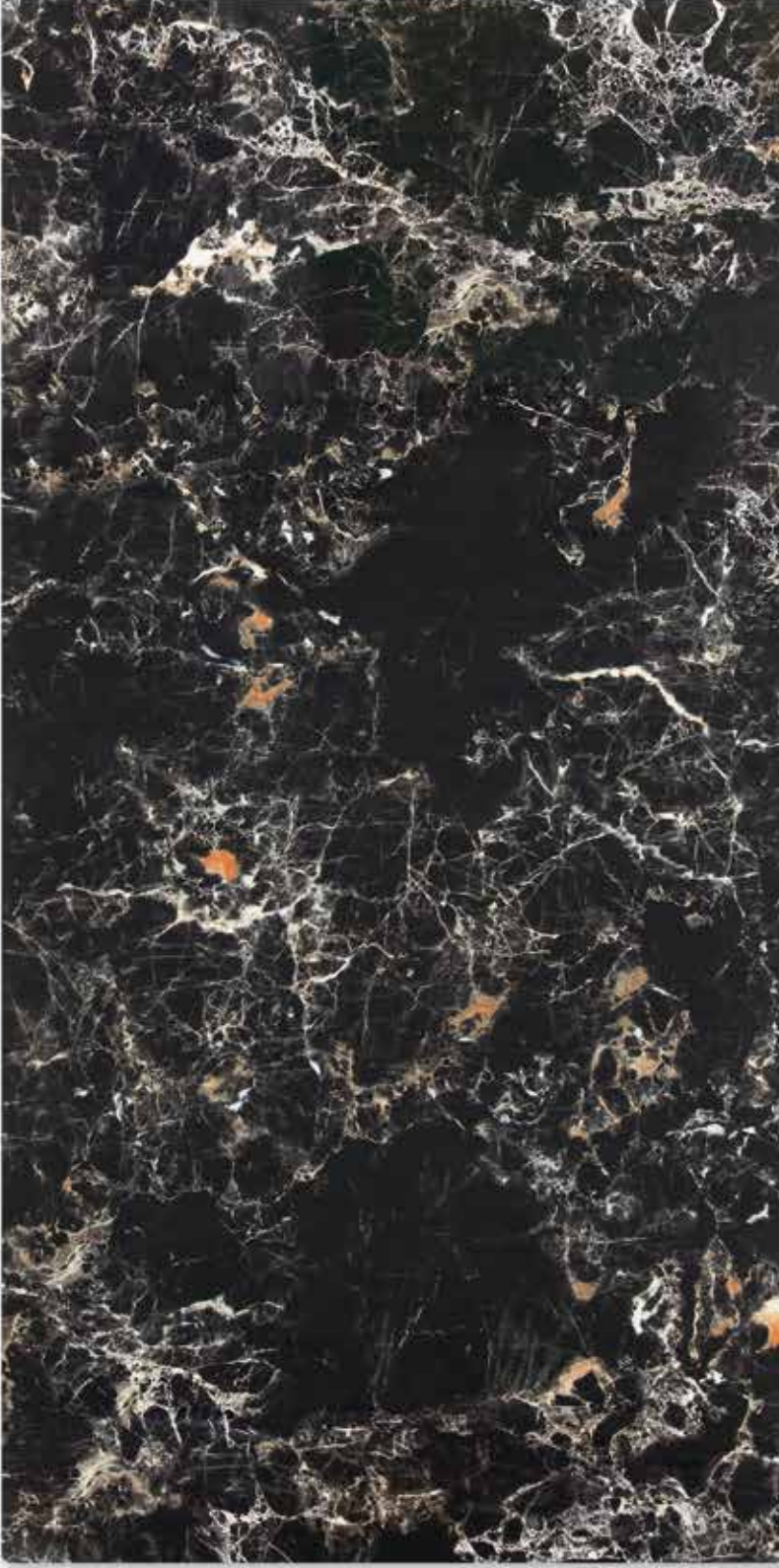

Ürün / Product	Ebat / Size (cm)	Birim / Unit (m ² /Ad/kg)	Kutu / Box			Palet / Pallet		
			(Ad-Pcs)	(m ²)	(kg)	(Kutu-Box)	(m ²)	(kg)
Porselen Karo / Porcelain Tiles	120x120	m ²	1	1,44	36,3	30	43,2	1,100
	60x120	m ²	2	1,44	36,3	29	41,76	1,080
	60x60	m ²	4	1,44	33	30	43,2	1,020

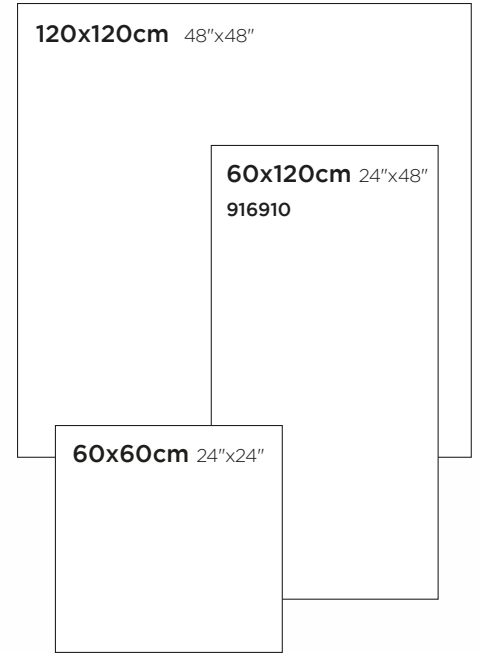

Ürün / Product	Ebat / Size (cm)	Birim / Unit (m ² /Ad/kg)	(Ad-Pcs)	Kutu / Box			Palet / Pallet		
				(m ²)	(kg)	(Kutu-Box)	(m ²)	(kg)	
Porselen Karo / Porcelain Tiles	120x120	m ²	1	1,44	36,3	30	43,2	1,100	
	60x120	m ²	2	1,44	36,3	29	41,76	1,080	
	60x60	m ²	4	1,44	33	30	43,2	1,020	



LECCINO



Sırlı Porselen Karo / Glazed Porcelain Tile

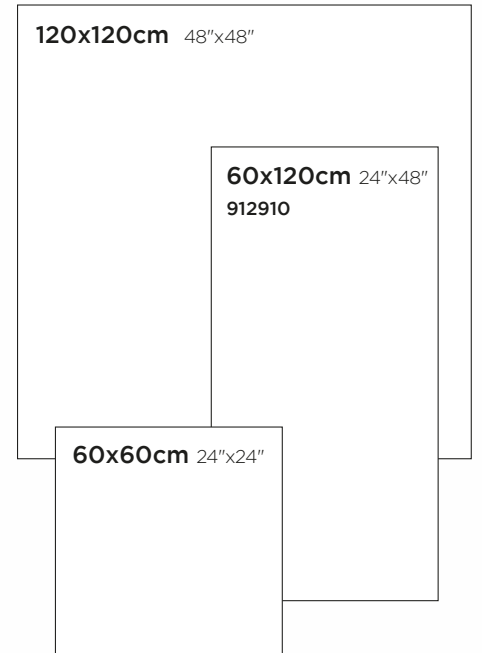

Ürün / Product	Ebat / Size (cm)	Birim / Unit (m ² /Ad/kg)	Kutu / Box			Palet / Pallet		
			(Ad-Pcs)	(m ²)	(kg)	(Kutu-Box)	(m ²)	(kg)
Porselen Karo / Porcelain Tiles	120x120	m ²	1	1,44	36,3	30	43,2	1,100
	60x120	m ²	2	1,44	36,3	29	41,76	1,080
	60x60	m ²	4	1,44	33	30	43,2	1,020

Parma Rosso



Parma Rosso, Castelo, Ephesus, Istanbul



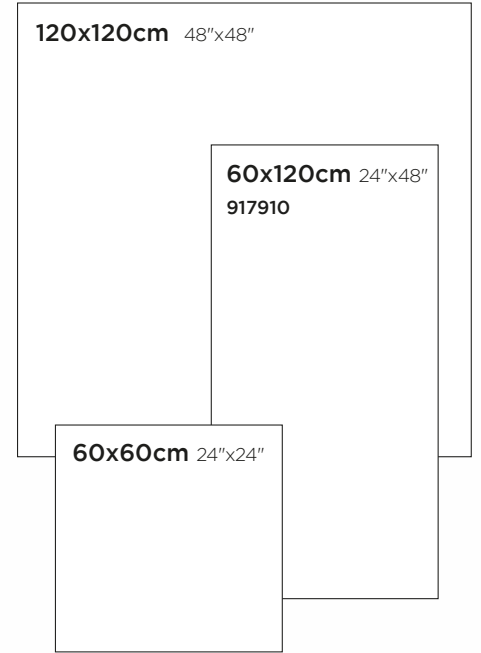
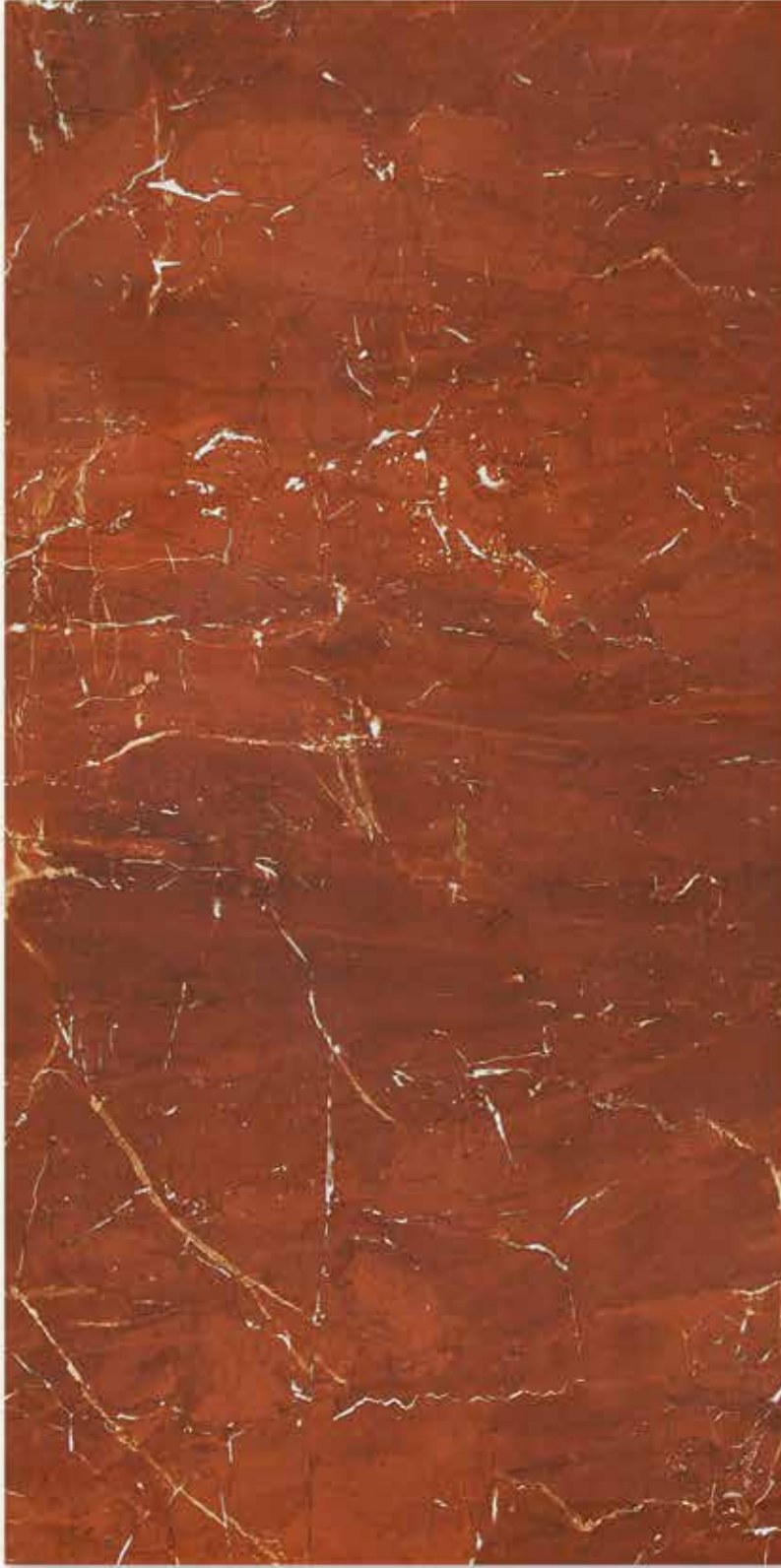

Ürün / Product	Ebat / Size (cm)	Birim / Unit (m ² /Ad/kg)	Kutu / Box			Palet / Pallet		
			(Ad-Pcs)	(m ²)	(kg)	(Kutu-Box)	(m ²)	(kg)
Porselen Karo / Porcelain Tiles	120x120	m ²	1	1,44	36,3	30	43,2	1,100
	60x120	m ²	2	1,44	36,3	29	41,76	1,080
	60x60	m ²	4	1,44	33	30	43,2	1,020

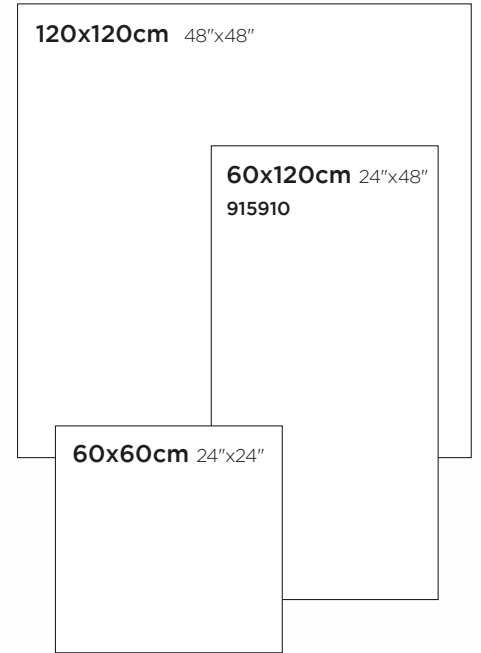

Ürün / Product	Ebat / Size (cm)	Birim / Unit (m ² /Ad/kg)	(Ad-Pcs)	Kutu / Box		Palet / Pallet		
				(m ²)	(kg)	(Kutu-Box)	(m ²)	(kg)
Porselen Karo / Porcelain Tiles	120x120	m ²	1	1,44	36,3	30	43,2	1,100
	60x120	m ²	2	1,44	36,3	29	41,76	1,080
	60x60	m ²	4	1,44	33	30	43,2	1,020

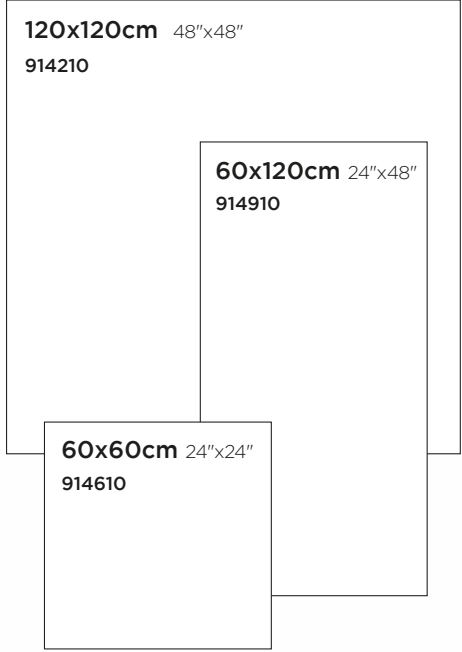



Castelo

Ürün / Product	Ebat / Size (cm)	Birim / Unit (m ² /Ad/kg)	(Ad-Pcs)	Kutu / Box		Palet / Pallet		
				(m ²)	(kg)	(Kutu-Box)	(m ²)	(kg)
Porselen Karo / Porcelain Tiles	120x120	m ²	1	1,44	36,3	30	43,2	1,100
	60x120	m ²	2	1,44	36,3	29	41,76	1,080
	60x60	m ²	4	1,44	33	30	43,2	1,020



TIVOLI Dark



Sırlı Porselen Karo / Glazed Porcelain Tile

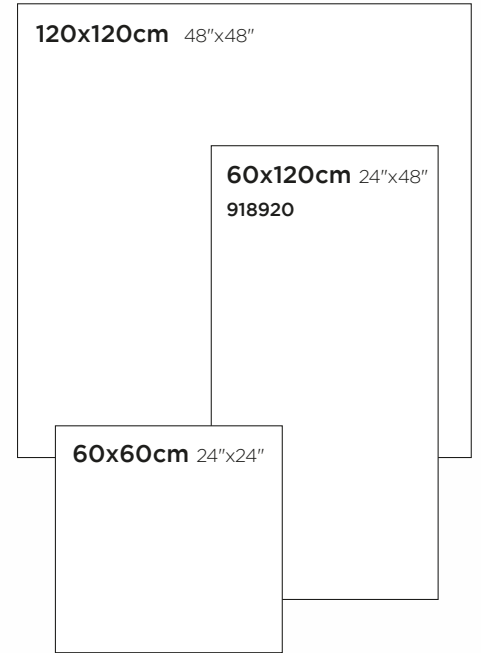

Ürün / Product	Ebat / Size (cm)	Birim / Unit (m ² /Ad/kg)	Kutu / Box			Palet / Pallet		
			(Ad-Pcs)	(m ²)	(kg)	(Kutu-Box)	(m ²)	(kg)
Porselen Karo / Porcelain Tiles	120x120	m ²	1	1,44	36,3	30	43,2	1,100
	60x120	m ²	2	1,44	36,3	29	41,76	1,080
	60x60	m ²	4	1,44	33	30	43,2	1,020



TIVOLI Light



Sırlı Porselen Karo / Glazed Porcelain Tile



HEL
3

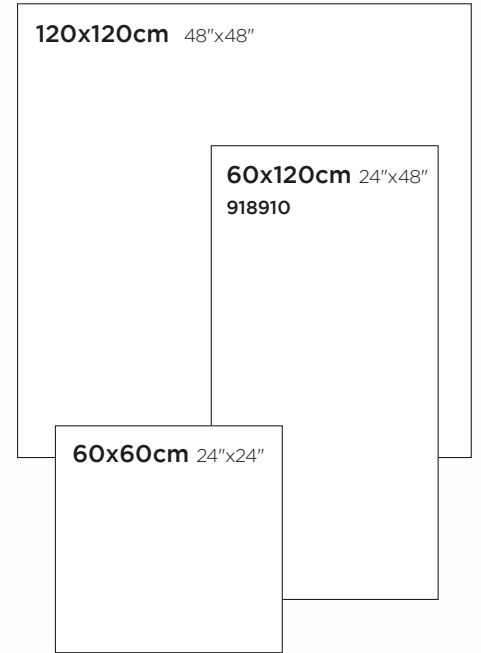

Ürün / Product	Ebat / Size (cm)	Birim / Unit (m ² /Ad/kg)	(Ad-Pcs)	Kutu / Box		Palet / Pallet		
				(m ²)	(kg)	(Kutu-Box)	(m ²)	(kg)
Porselen Karo / Porcelain Tiles	120x120	m ²	1	1,44	36,3	30	43,2	1,100
	60x120	m ²	2	1,44	36,3	29	41,76	1,080
	60x60	m ²	4	1,44	33	30	43,2	1,020



ASIA

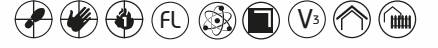

Sırlı Porselen Karo / Glazed Porcelain Tile



60x120cm 24"x48"
231901



Ürün / Product	Ebat / Size (cm)	Birim / Unit (m ² /Ad/kg)	Kutu / Box			Palet / Pallet		
			(Ad-Pcs)	(m ²)	(kg)	(Kutu-Box)	(m ²)	(kg)
Porselen Karo / Porcelain Tiles	60x120	m ²	2	1,44	36,3	29	41,76	1,080

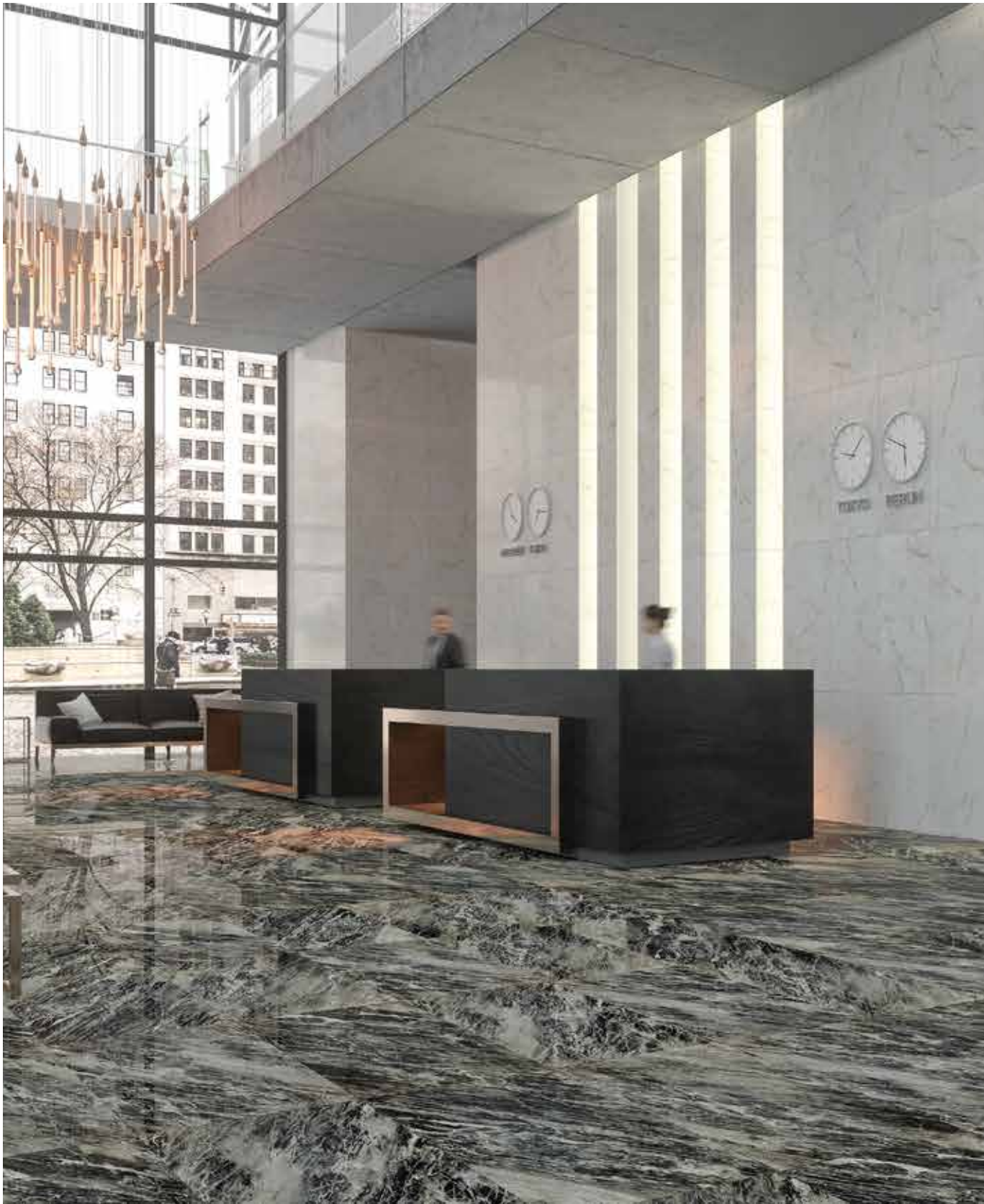

Asia, New Orleans



NEW ORLEANS Beyaz / White



Sırlı Porselen Karo / Glazed Porcelain Tile

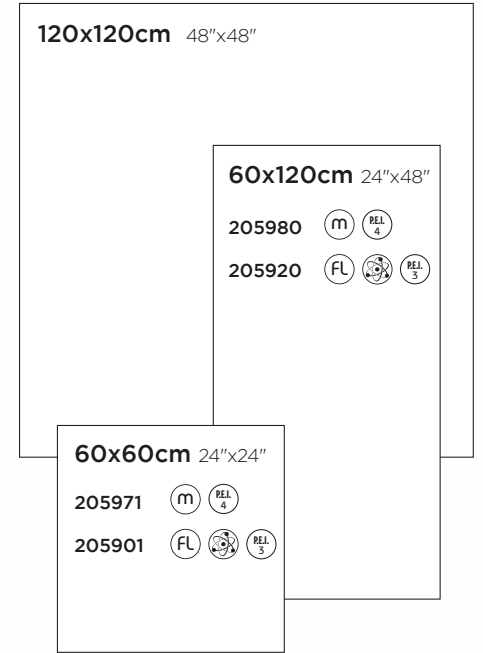

Ürün / Product	Ebat / Size (cm)	Birim / Unit (m ² /Ad/kg)	Kutu / Box			Palet / Pallet		
			(Ad-Pcs)	(m ²)	(kg)	(Kutu-Box)	(m ²)	(kg)
Porselen Karo / Porcelain Tiles	120x120	m ²	1	1,44	36,3	30	43,2	1,100
	60x120	m ²	2	1,44	36,3	29	41,76	1,080
	60x60	m ²	4	1,44	33	30	43,2	1,020



New Orleans



REL 3

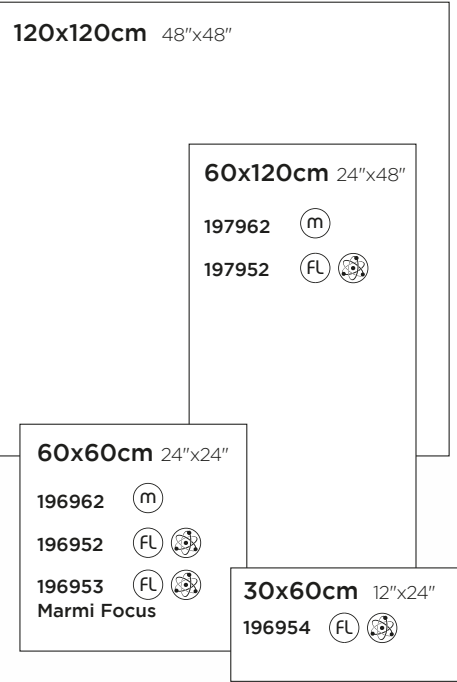



Calacatta Marmi, Marmi Focus



Marmi Focus

Ürün / Product	Ebat / Size (cm)	Birim / Unit (m ² /Ad/kg)	(Ad-Pcs)	Kutu / Box		Palet / Pallet		
				(m ²)	(kg)	(Kutu-Box)	(m ²)	(kg)
Porselen Karo / Porcelain Tiles	120x120	m ²	1	1,44	36,3	30	43,2	1,100
	60x120	m ²	2	1,44	36,3	29	41,76	1,080
	60x60	m ²	4	1,44	33	30	43,2	1,020
	30x60	m ²	7	1,26	30,9	32	40,32	1,020



MILANO Beyaz / White



Sırlı Porselen Karo / Glazed Porcelain Tile (FL) (3)

Porselen Karo / Porcelain Tile "UGL" (m) (FB)



(m)

- TS-EN 14411 standardına göre aşınma $< 175 \text{ mm}^3$ değerine uygun olarak üretilir.
- Abrasion resistance value of porcelain tile is $< 175 \text{ mm}^3$ according to TS-EN 14411.

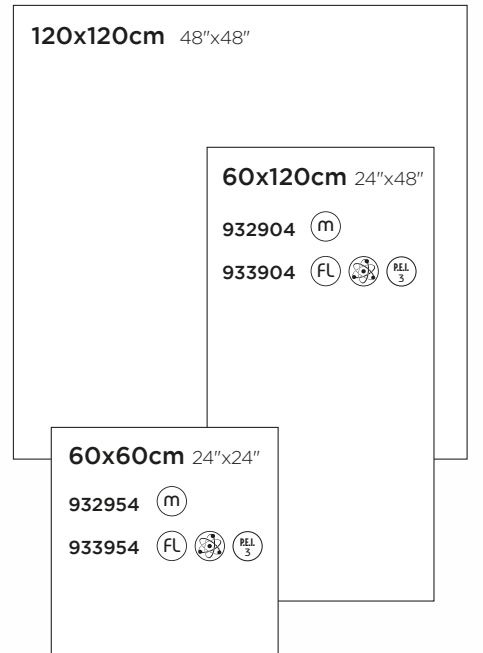

Ürün / Product	Ebat / Size (cm)	Birim / Unit (m ² /Ad/kg)	Kutu / Box			Palet / Pallet		
			(Ad-Pcs)	(m ²)	(kg)	(Kutu-Box)	(m ²)	(kg)
Porselen Karo / Porcelain Tiles	120x120	m ²	1	1,44	36,3	30	43,2	1,100
	60x120	m ²	2	1,44	36,3	29	41,76	1,080
	60x60	m ²	4	1,44	33	30	43,2	1,020



MILANO Gri / Grey



Sırlı Porselen Karo / Glazed Porcelain Tile **FL**

Porselen Karo / Porcelain Tile "UGL" **m** **FB**



m

- TS-EN 14411 standardına göre aşınma < 175 mm³ değerine uygun olarak üretilir.
- Abrasion resistance value of porcelain tile is < 175 mm³ according to TS-EN 14411.

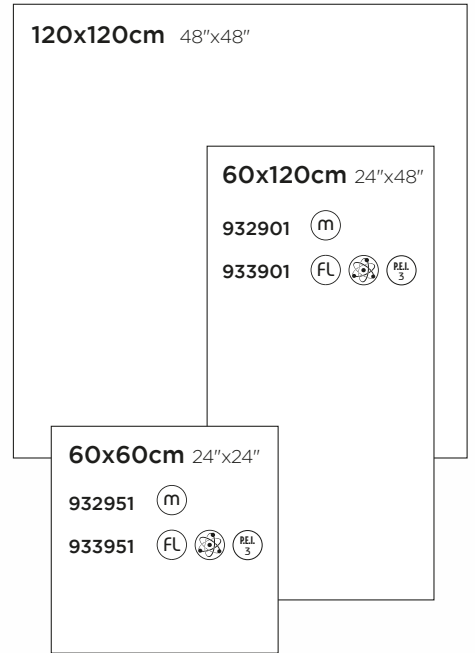

Ürün / Product	Ebat / Size (cm)	Birim / Unit (m ² /Ad/kg)	Kutu / Box			Palet / Pallet		
			(Ad-Pcs)	(m ²)	(kg)	(Kutu-Box)	(m ²)	(kg)
Porselen Karo / Porcelain Tiles	120x120	m ²	1	1,44	36,3	30	43,2	1,100
	60x120	m ²	2	1,44	36,3	29	41,76	1,080
	60x60	m ²	4	1,44	33	30	43,2	1,020



MILANO Bej / Beige



Sırlı Porselen Karo / Glazed Porcelain Tile **FL**

Porselen Karo / Porcelain Tile "UGL" **m** **FB**



m

- TS-EN 14411 standardına göre aşınma < 175 mm³ değerine uygun olarak üretilir.
- Abrasion resistance value of porcelain tile is < 175 mm³ according to TS-EN 14411.

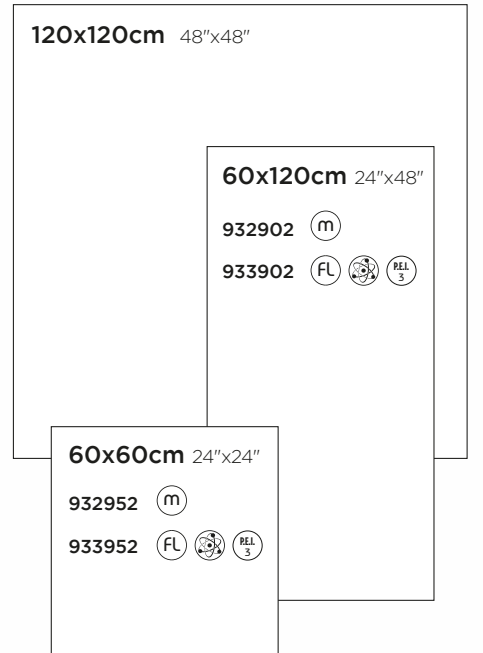

Ürün / Product	Ebat / Size (cm)	Birim / Unit (m ² /Ad/kg)	Kutu / Box			Palet / Pallet		
			(Ad-Pcs)	(m ²)	(kg)	(Kutu-Box)	(m ²)	(kg)
Porselen Karo / Porcelain Tiles	120x120	m ²	1	1,44	36,3	30	43,2	1,100
	60x120	m ²	2	1,44	36,3	29	41,76	1,080
	60x60	m ²	4	1,44	33	30	43,2	1,020



MILANO Siyah / Black



Sırlı Porselen Karo / Glazed Porcelain Tile **FL**

Porselen Karo / Porcelain Tile **"UGL"** **m** **FB**

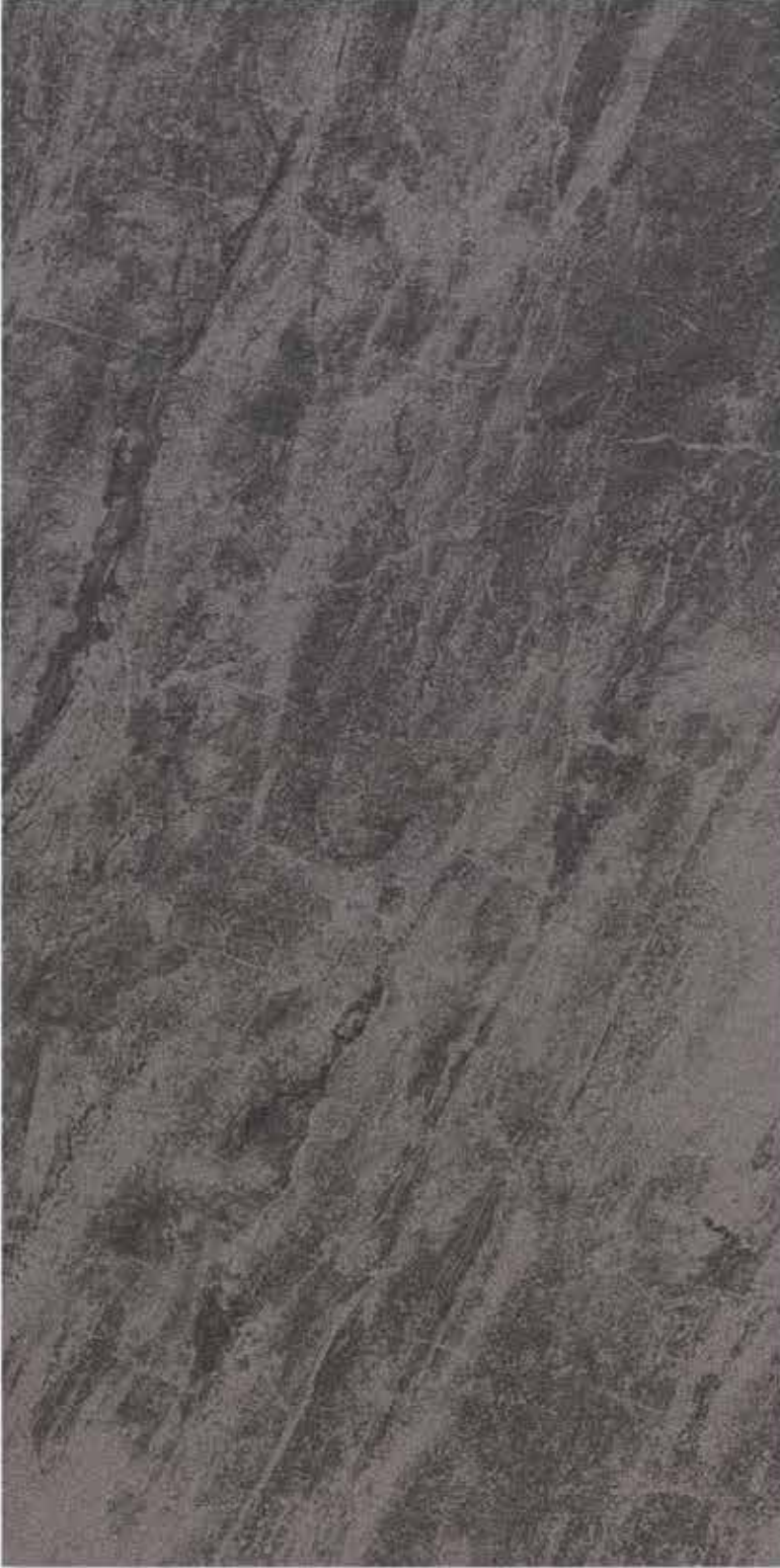

m

- TS-EN 14411 standardına göre aşınma < 175 mm³ değerine uygun olarak üretilir.
- Abrasion resistance value of porcelain tile is < 175 mm³ according to TS-EN 14411.

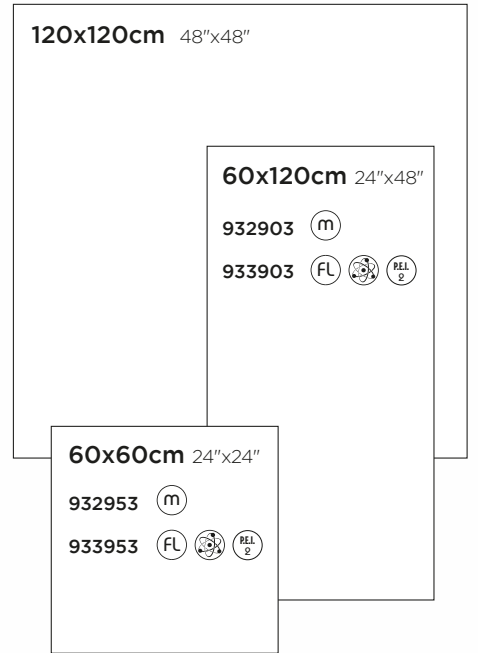

Ürün / Product	Ebat / Size (cm)	Birim / Unit (m ² /Ad/kg)	Kutu / Box			Palet / Pallet		
			(Ad-Pcs)	(m ²)	(kg)	(Kutu-Box)	(m ²)	(kg)
Porselen Karo / Porcelain Tiles	120x120	m ²	1	1,44	36,3	30	43,2	1,100
	60x120	m ²	2	1,44	36,3	29	41,76	1,080
	60x60	m ²	4	1,44	33	30	43,2	1,020

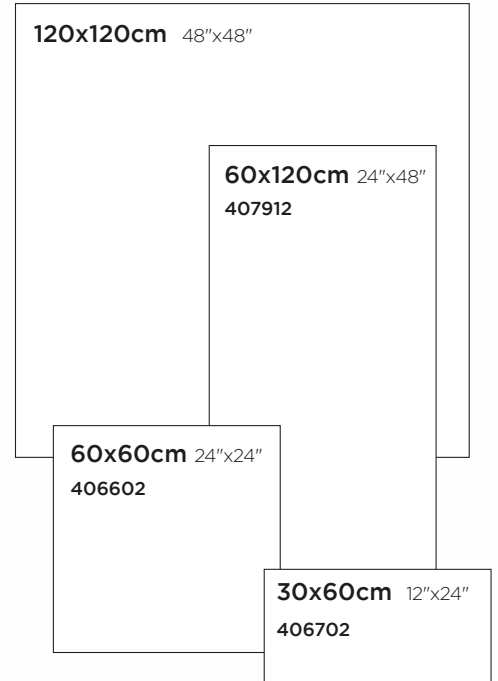

Ürün / Product	Ebat / Size (cm)	Birim / Unit (m ² /Ad/kg)	Kutu / Box			Palet / Pallet		
			(Ad-Pcs)	(m ²)	(kg)	(Kutu-Box)	(m ²)	(kg)
Porselen Karo / Porcelain Tiles	120x120	m ²	1	1,44	36,3	30	43,2	1,100
	60x120	m ²	2	1,44	36,3	29	41,76	1,080
	60x60	m ²	4	1,44	33	30	43,2	1,020
	30x60	m ²	7	1,26	30,9	32	40,32	1,020

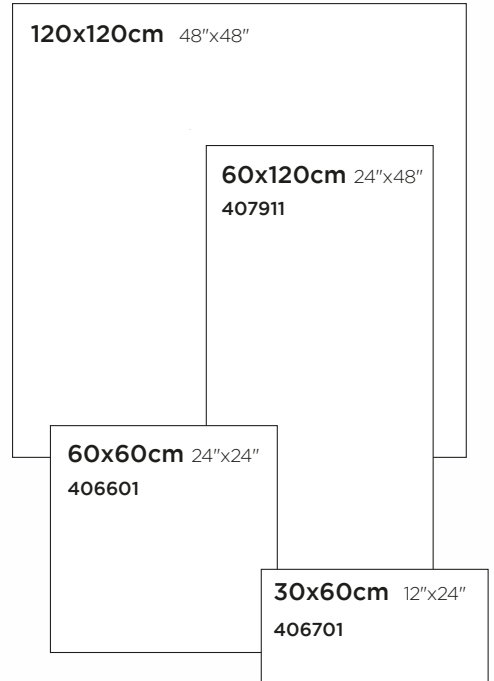
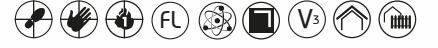

Ürün / Product	Ebat / Size (cm)	Birim / Unit (m ² /Ad/kg)	Kutu / Box			Palet / Pallet		
			(Ad-Pcs)	(m ²)	(kg)	(Kutu-Box)	(m ²)	(kg)
Porselen Karo / Porcelain Tiles	120x120	m ²	1	1,44	36,3	30	43,2	1,100
	60x120	m ²	2	1,44	36,3	29	41,76	1,080
	60x60	m ²	4	1,44	33	30	43,2	1,020
	30x60	m ²	7	1,26	30,9	32	40,32	1,020

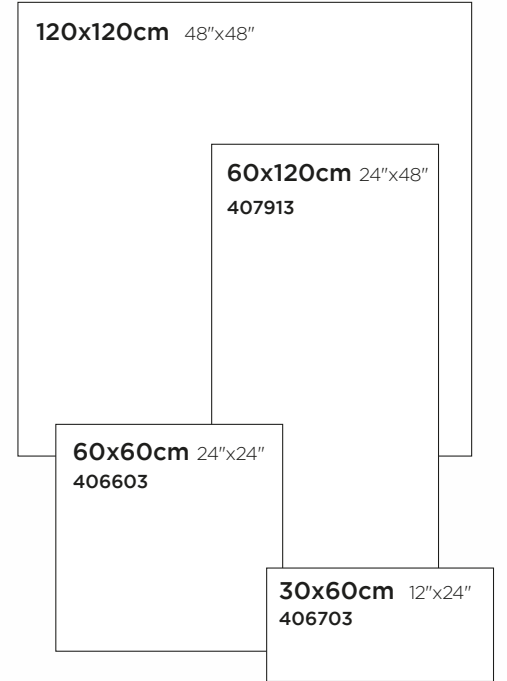
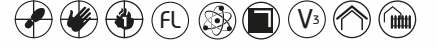

Ürün / Product	Ebat / Size (cm)	Birim / Unit (m ² /Ad/kg)	Kutu / Box			Palet / Pallet		
			(Ad-Pcs)	(m ²)	(kg)	(Kutu-Box)	(m ²)	(kg)
Porselen Karo / Porcelain Tiles	120x120	m ²	1	1,44	36,3	30	43,2	1,100
	60x120	m ²	2	1,44	36,3	29	41,76	1,080
	60x60	m ²	4	1,44	33	30	43,2	1,020
	30x60	m ²	7	1,26	30,9	32	40,32	1,020

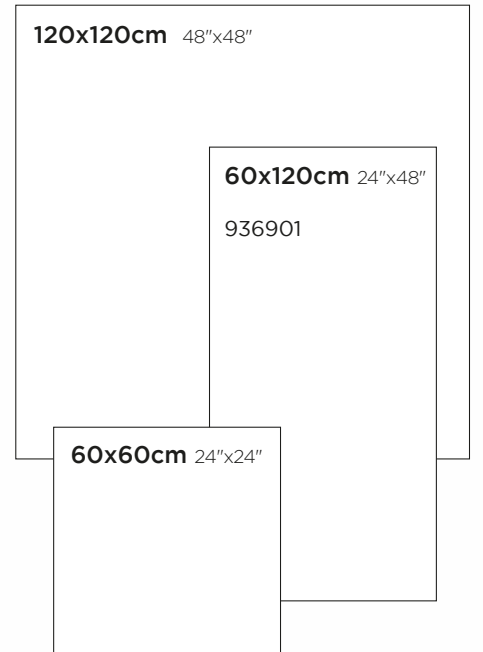
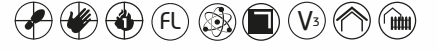

Ürün / Product	Ebat / Size (cm)	Birim / Unit (m ² /Ad/kg)	(Ad-Pcs)	Kutu / Box			Palet / Pallet		
				(m ²)	(kg)	(Kutu-Box)	(m ²)	(kg)	
Porselen Karo / Porcelain Tiles	120x120	m ²	1	1,44	36,3	30	43,2	1,100	
	60x120	m ²	2	1,44	36,3	29	41,76	1,080	
	60x60	m ²	4	1,44	33	30	43,2	1,020	



60x120cm 24"x48"
195901

Ürün / Product	Ebat / Size (cm)	Birim / Unit (m ² /Ad/kg)	Kutu / Box			Palet / Pallet		
			(Ad-Pcs)	(m ²)	(kg)	(Kutu-Box)	(m ²)	(kg)
Porselen Karo / Porcelain Tiles	60x120	m ²	2	1,44	36,3	29	41,76	1,080



- TS-EN 14411 standardına göre aşınma < 175 mm³ değerine uygun olarak üretilir.
- Abrasion resistance value of porcelain tile is < 175 mm³ according to TS-EN 14411.

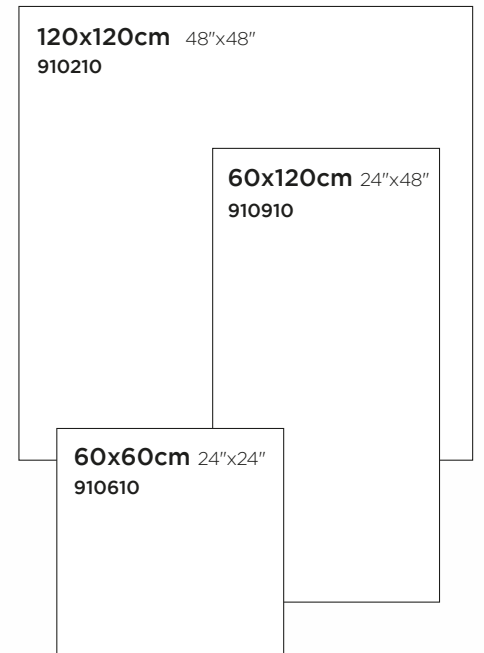

Ürün / Product	Ebat / Size (cm)	Birim / Unit (m ² /Ad/kg)	Kutu / Box			Palet / Pallet		
			(Ad-Pcs)	(m ²)	(kg)	(Kutu-Box)	(m ²)	(kg)
Porselen Karo / Porcelain Tiles	120x120	m ²	1	1,44	36,3	30	43,2	1,100
	60x120	m ²	2	1,44	36,3	29	41,76	1,080
	60x60	m ²	4	1,44	33	30	43,2	1,020

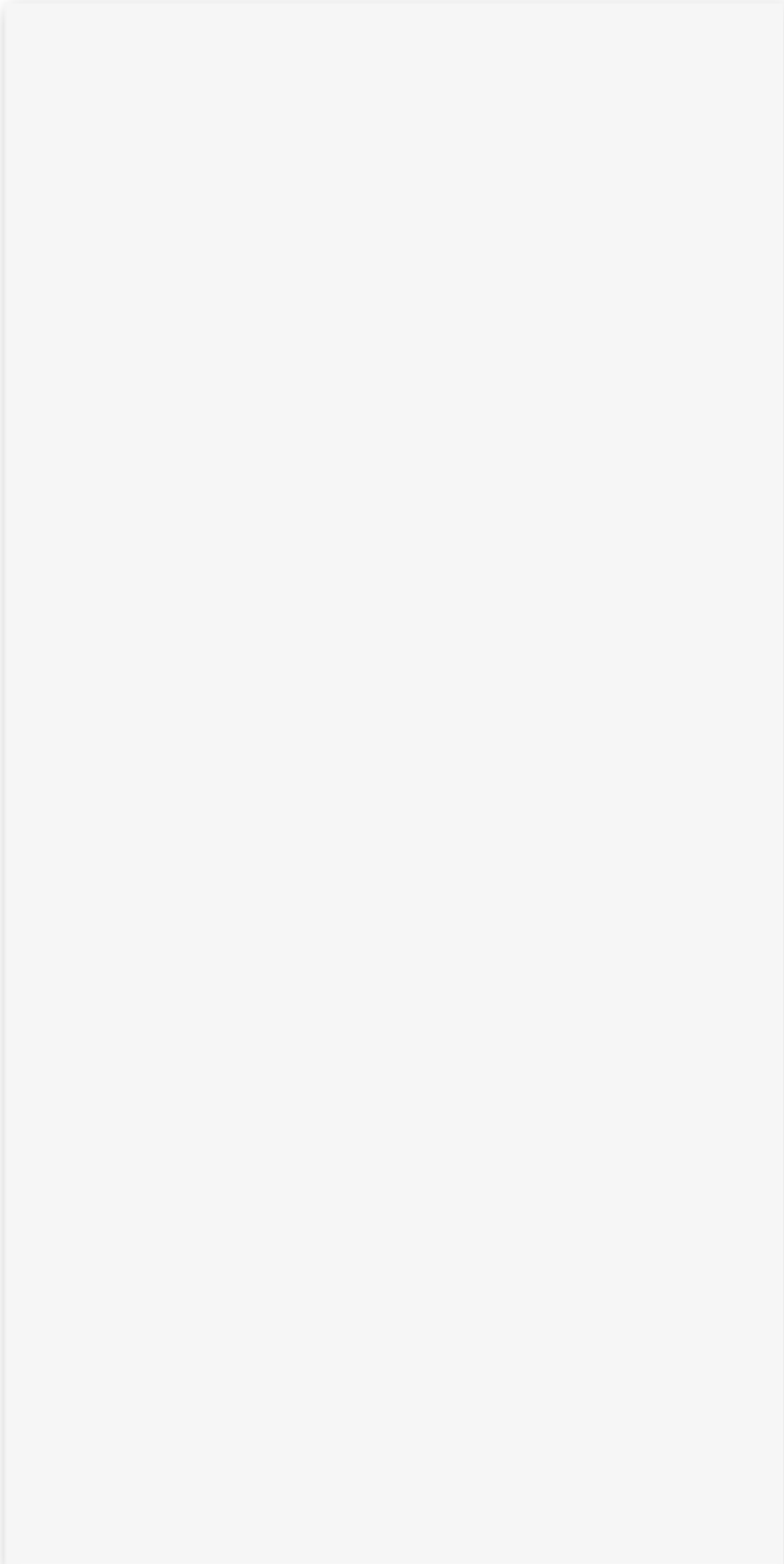

Süper Beyaz / Super White

- TS-EN 14411 standardına göre aşınma $< 175 \text{ mm}^3$ değerine uygun olarak üretilir.
- Abrasion resistance value of porcelain tile is $< 175 \text{ mm}^3$ according to TS-EN 14411.

30x60cm 12"x24"

920951 Süper Beyaz / Super White

920900 Kemik / Bone

920952 Siyah / Black

60x60cm 24"x24"

921951 Süper Beyaz / Super White

921950 Kemik / Bone

921952 Siyah / Black

60x120cm 24"x48"

924951 Süper Beyaz / Super White

924950 Kemik / Bone

Ürün / Product	Ebat / Size (cm)	Birim / Unit (m ² /Ad/kg)	Kutu / Box			Palet / Pallet		
			(Ad-Pcs)	(m ²)	(kg)	(Kutu-Box)	(m ²)	(kg)
Porselen Karo / Porcelain Tiles	60x120	m ²	2	1,44	36,3	29	41,76	1,080
	60x60	m ²	4	1,44	33	30	43,2	1,020
	30x60	m ²	8	1,44	32,7	32	46,08	1,100

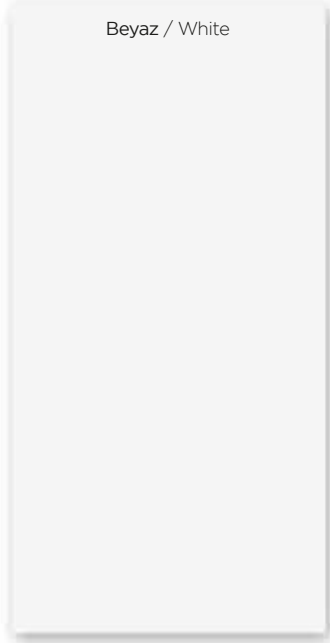

- TS-EN 14411 standardına göre aşınma $< 175 \text{ mm}^3$ değerine uygun olarak üretilir.
- Abrasion resistance value of porcelain tile is $< 175 \text{ mm}^3$ according to TS-EN 14411.

Ürün / Product	Ebat / Size (cm)	Birim / Unit (m ² /Ad/kg)	Kutu / Box			Palet / Pallet		
			(Ad-Pcs)	(m ²)	(kg)	(Kutu-Box)	(m ²)	(kg)
Porselen Karo / Porcelain Tiles	60x120	m ²	2	1,44	36,3	29	41,76	1,080
	60x60	m ²	4	1,44	33	30	43,2	1,020
	30x60	m ²	8	1,44	32,7	32	46,08	1,100



- TS-EN 14411 standardına göre aşınma $< 175 \text{ mm}^3$ değerine uygun olarak üretilir.
- Abrasion resistance value of porcelain tile is $< 175 \text{ mm}^3$ according to TS-EN 14411.



- TS-EN 14411 standardına göre aşınma $< 175 \text{ mm}^3$ değerine uygun olarak üretilir.
- Abrasion resistance value of porcelain tile is $< 175 \text{ mm}^3$ according to TS-EN 14411.



Beyaz / White

120x120cm 48"x48"

228911 Açık Gri / Light Grey

60x120cm 24"x48"

227901 Beyaz / White

227903 Açık Gri / Light Grey

227904 Gri / Grey

227902 Siyah / Black

60x60cm 24"x24"

226901 Beyaz / White

226903 Açık Gri / Light Grey

226904 Gri / Grey

226902 Siyah / Black

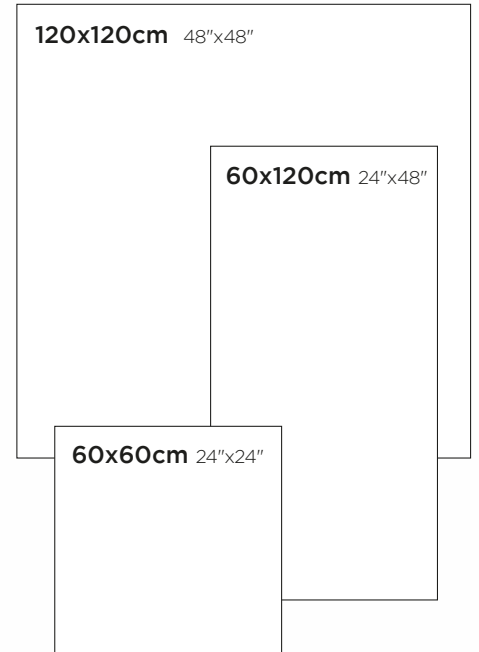

Ürün / Product	Ebat / Size (cm)	Birim / Unit (m ² /Ad/kg)	Kutu / Box			Palet / Pallet		
			(Ad-Pcs)	(m ²)	(kg)	(Kutu-Box)	(m ²)	(kg)
Porselen Karo / Porcelain Tiles	120x120	m ²	1	1,44	36,3	30	43,2	1,100
	60x120	m ²	2	1,44	36,3	29	41,76	1,080
	60x60	m ²	4	1,44	33	30	43,2	1,020

SERAMİKSAN'DAN YENİ BİR ADIM **SERASTEP**

A NEW STEP FROM SERAMİKSAN SERASTEP

Kolay temizlenen, leke tutmayan ve dayanıklı yapısı ile porselenin şıklığı, Seramiksan ile basamaklarınıza yansıyor.

Özel sipariş ile tercih edilen boyutta, tek gövde olarak üretilen merdiven basamakları, bir seferde rahatlıkla monte edilebiliyor. Gövdesinde yer alan ve kaymayı engelleyen çizgileri ile porselen karolarının merdivenlerde kullanılmasına olanak sağlayarak, mekanlar arasında malzeme bütünlüğü oluşturuyor.

Ahşap, doğal taş ve mermer görünümlü üç farklı doku seçeneği, aynı malzeme ile döşenebilen süpürgelik ve köşe kaplamaları, sonsuz seçenekte riht tasarımı sunan Serastep ile, iç ve dış mekanlarınızda hayal edebileceklerinizin sınırı yok.

The easily cleaned, stainless features and durability of porcelain is reflected to your staircases by the elegance of Seramiksan.

Produced as per order in the size of your choice as monobloc, Serastep can be practiced with ease at once. It provides material integrity between spaces, enabling the application of porcelain floor tiles on stairs through its anti-skid lines on its body.

Offering three different texture choices of wood, concrete and marble, skirtings and corner coverings of the same material, and innumerable options of riser designs, there is no limit to your imagination decorating your indoor and outdoor spaces with Serastep.







30x120 cm / 12"x48"
İstanbul Merdiven Basamağı Beyaz / Istanbul Step White

BB227901



8x120 cm / 3,2"x48"
İstanbul Süpürgelik Beyaz / Istanbul Skirting White

BA227901



30x120 cm / 12"x48"
İstanbul Merdiven Basamağı Açık Gri / Istanbul Step Light Grey

BB227903



8x120 cm / 3,2"x48"
İstanbul Süpürgelik Açık Gri / Istanbul Skirting Light Grey

BA227903



30x120 cm / 12"x48"
İstanbul Merdiven Basamağı Gri / Istanbul Step Grey

BB227904



8x120 cm / 3,2"x48"
İstanbul Süpürgelik Gri / Istanbul Skirting Grey

BA227904



30x120 cm / 12"x48"
İstanbul Merdiven Basamağı Siyah / Istanbul Step Black

BB227902



8x120 cm / 3,2"x48"
İstanbul Süpürgelik Siyah / Istanbul Skirting Black

BA227902



BB934901
30x120 cm / 12"x48"
Black Marble Merdiven Basamağı / Black Marble Step



BA934901
8x120 cm / 4"x48"
Black Marble Süpürgelik / Black Marble Skirting

Ev içi kullanıma uygundur. / Suitable for residential usage.



BB934920
30x120 cm / 12"x48"
Nat. Black Marble Merdiven Basamağı / Nat. Black Marble Step



BA934920
8x120 cm / 4"x48"
Nat. Black Marble Süpürgelik / Nat. Black Marble Skirting

Ev içi kullanıma uygundur. / Suitable for residential usage.

Ürün / Product	Ebat / Size (cm)	Birim / Unit (m ² /Ad/kg)	Kutu / Box			Palet / Pallet		
			(Ad-Pcs)	(m ²)	(kg)	(Kutu-Box)	(m ²)	(kg)
Merdiven Basamağı	30x120	m ²	3	1,08	26	26	28,08	690
Süpürgelik / Skirting	8x120	m ²	4	0,384	9,6	70	26,88	687



30x120 cm / 12"x48"
Monte Verde Gri Merdiven Basamağı / Monte Verde Grey Step

BB905401



8x120 cm / 4"x48"
Monte Verde Gri Süpürgelik / Monte Verde Grey Skirting

BA905401



30x120 cm / 12"x48"
Monte Verde Zeytin Merdiven Basamağı / Monte Verde Olive Step

BB905402



8x120 cm / 4"x48"
Monte Verde Zeytin Süpürgelik / Monte Verde Olive Skirting

BA905402



30x120 cm / 12"x48"
Monte Verde Mix Merdiven Basamağı / Monte Verde Mix Step

BB905400



8x120 cm / 4"x48"
Monte Verde Mix Süpürgelik / Monte Verde Mix Skirting

BA905400



30x120 cm / 12"x48"
Monte Verde Maun Merdiven Basamağı / Monte Verde Maun Step

BB905403



8x120 cm / 4"x48"
Monte Verde Maun Süpürgelik / Monte Verde Maun Skirting

BA905403



30x120 cm / 12"x48"
Daintree Beyaz Merdiven Basamağı / Daintree White Step

BB903400



8x120 cm / 4"x48"
Daintree Beyaz Süpürgelik / Daintree White Skirting

BA903400

Ürün / Product	Ebat / Size (cm)	Birim / Unit (m ² /Ad/kg)	Kutu / Box			Palet / Pallet		
			(Ad-Pcs)	(m ²)	(kg)	(Kutu-Box)	(m ²)	(kg)
Merdiven Basamağı	30x120	m ²	3	1,08	26	26	28,08	690
Süpürgelik / Skirting	8x120	m ²	4	0,384	9,6	70	26,88	687



30x120 cm / 12"x48"
Sagano Gri Merdiven Basamađı / Sagano Grey Step

BB904401



8x120 cm / 4"x48"
Sagano Gri Süpürgelik / Sagano Grey Skirting

BA904401



30x120 cm / 12"x48"
Sagano Badem Merdiven Basamađı / Sagano Almond Step

BB904402



8x120 cm / 4"x48"
Sagano Badem Süpürgelik / Sagano Almond Skirting

BA904402



30x120 cm / 12"x48"
Sagano Ceviz Merdiven Basamađı / Sagano Noce Step

BB904403



8x120 cm / 4"x48"
Sagano Ceviz Süpürgelik / Sagano Noce Skirting

BA904403



30x120 cm / 12"x48"
Sagano Oak Merdiven Basamađı / Sagano Oak Step

BB904404



8x120 cm / 4"x48"
Sagano Oak Süpürgelik / Sagano Oak Skirting

BA904404



30x120 cm / 12"x48"
Sagano Kestane Merdiven Basamađı / Sagano Chestnut Step

BB904400



8x120 cm / 4"x48"
Sagano Kestane Sprgelik / Sagano Chestnut Skirting

BA904400

rn / Product	Ebat / Size (cm)	Birim / Unit (m ² /Ad/kg)	Kutu / Box			Palet / Pallet		
			(Ad-Pcs)	(m ²)	(kg)	(Kutu-Box)	(m ²)	(kg)
Merdiven Basamađı	30x120	m ²	3	1,08	26	26	28,08	690
Sprgelik / Skirting	8x120	m ²	4	0,384	9,6	70	26,88	687

AĞAÇ KADAR DOĞAL VE DAYANIKLI

AS NATURAL AND STRONG AS WOOD

Teknolojinin gelişimi; yaşam tarzlarını, mekanları, şehirleri değiştirerek insanları doğadan uzaklaştırırsa da insanoğlunun doğaya olan özlemi gün geçtikçe artıyor. Özellikle iç mekan dekorasyonlarında doğadan esintiler taşıyan malzemeler en çok tercih edilenler arasında. Seramiksan'ın digiart teknolojisiyle ürettiği seramikleri, doğanın tüm canlılığını ve renklerini yansıtıyor.

Even though the development of technology draws people away from the nature by changing the life styles, living places, and cities, the aspiration of people and their longing for the nature increases day by day. Especially those materials which have a feel of the nature in indoor decorations are among those which are the most preferred. The tiles manufactured by Seramiksan by use of digiart technology reflect the whole liveliness and colors of the nature.







904401
20x120 cm / 8"x48"
Gri / Grey



904402
20x120 cm / 8"x48"
Badem / Almond

- TS-EN 14411 standardına göre aşınma < 175 mm³ değerine uygun olarak üretilir.
- Abrasion resistance value of porcelain tile is < 175 mm³ according to TS-EN 14411.

Ürün / Product	Ebat / Size (cm)	Birim / Unit (m ² /Ad/kg)	(Ad-Pcs)	Kutu / Box		Palet / Pallet		
				(m ²)	(kg)	(Kutu-Box)	(m ²)	(kg)
Porselen Karo / Porcelain Tiles	20x120	m ²	4	0,96	23	36	34,56	850



904403
20x120 cm / 8"x48"
Ceviz / Noce



904404
20x120 cm / 8"x48"
Oak / Oak

- TS-EN 14411 standardına göre aşınma < 175 mm³ değerine uygun olarak üretilir.
- Abrasion resistance value of porcelain tile is < 175 mm³ according to TS-EN 14411.

Ürün / Product	Ebat / Size (cm)	Birim / Unit (m ² /Ad/kg)	Kutu / Box			Palet / Pallet		
			(Ad-Pcs)	(m ²)	(kg)	(Kutu-Box)	(m ²)	(kg)
Porselen Karo / Porcelain Tiles	20x120	m ²	4	0,96	23	36	34,56	850



903400
20x120 cm / 8"x48"
Beyaz / White

- TS-EN 14411 standardına göre aşınma < 175 mm³ değerine uygun olarak üretilir.
- Abrasion resistance value of porcelain tile is < 175 mm³ according to TS-EN 14411.

Ürün / Product	Ebat / Size (cm)	Birim / Unit (m ² /Ad/kg)	Kutu / Box			Palet / Pallet		
			(Ad-Pcs)	(m ²)	(kg)	(Kutu-Box)	(m ²)	(kg)
Porselen Karo / Porcelain Tiles	20x120	m ²	4	0,96	23	36	34,56	850



OSLO



Sırlı Porselen Karo / Glazed Porcelain Tile



315912
15x90cm 6"x36"
Gri / Grey



315922
15x90cm 6"x36"
Lace Gri Motif / Lace Grey Motif



315911
15x90cm 6"x36"
Bej / Beige



315921
15x90cm 6"x36"
Lace Bej Motif / Lace Beige Motif



- Ürün fonu 16 farklı, motifler 4 farklı tasarımdan oluşur, bu nedenle kutular içerisinden farklı desenler çıkabilir.
- Since the product has 16 different faces and motifs have 4 different faces, you may receive different patterns in the boxes.

Ürün / Product	Ebat / Size (cm)	Birim / Unit (m ² /Ad/kg)	(Ad-Pcs)	Kutu / Box		Palet / Pallet		
				(m ²)	(kg)	(Kutu-Box)	(m ²)	(kg)
Porselen Karo / Porcelain Tiles	15x90	m ²	9	1,22	24,50	48	58,56	1,200



Oslo Bej, Castelo / Oslo Beige, Castelo



STIL



Sırlı Porselen Karo / Glazed Porcelain Tile



319911
15x90cm 6"x36"
Mavi / Blue

PEL 4

- Ürün fonu 12 farklı tasarımdan oluşur, bu nedenle kutular içerisinde farklı desenler çıkabilir.
- Since the product has 12 different faces, you may receive different patterns in the boxes.

VISTA



Sırlı Porselen Karo / Glazed Porcelain Tile



318911
15x90cm 6"x36"
Kahve / Brown

PEL 5

- Ürün fonu 12 farklı tasarımdan oluşur, bu nedenle kutular içerisinde farklı desenler çıkabilir.
- Since the product has 12 different faces, you may receive different patterns in the boxes.

Ürün / Product	Ebat / Size (cm)	Birim / Unit (m ² /Ad/kg)	Kutu / Box			Palet / Pallet		
			(Ad-Pcs)	(m ²)	(kg)	(Kutu-Box)	(m ²)	(kg)
Porselen Karo / Porcelain Tiles	15x90	m ²	9	1,22	24,50	48	58,56	1,200



RIGA



Sırlı Porselen Karo / Glazed Porcelain Tile



317912
15x90cm 6"x36"
Gri / Grey



317913
15x90cm 6"x36"
Kızıl / Red



317911
15x90cm 6"x36"
Bej / Beige



- Ürün fonu 16 farklı tasarımdan oluşur, bu nedenle kutular içerisinde farklı desenler çıkabilir.
- Since the product has 16 different faces, you may receive different patterns in the boxes.

Ürün / Product	Ebat / Size (cm)	Birim / Unit (m ² /Ad/kg)	(Ad-Pcs)	Kutu / Box		Palet / Pallet		
				(m ²)	(kg)	(Kutu-Box)	(m ²)	(kg)
Porselen Karo / Porcelain Tiles	15x90	m ²	9	1,22	24,50	48	58,56	1,200



MALMO Bej / Beige



Sırlı Porselen Karo / Glazed Porcelain Tile



312911
15x90cm 6"x36"
Bej / Beige



314911
15x90cm 6"x36"
Enna Bej Motif / Enna Beige Motif



313911
15x90cm 6"x36"
Ponte Bej Motif / Ponte Beige Motif



- Ürün fonu 16 farklı, motifler 4 farklı tasarımdan oluşur, bu nedenle kutular içerisinde farklı desenler çıkabilir.
- Since the product has 16 different faces and motifs have 4 different faces, you may receive different patterns in the boxes.

Ürün / Product	Ebat / Size (cm)	Birim / Unit (m ² /Ad/kg)	Kutu / Box			Palet / Pallet		
			(Ad-Pcs)	(m ²)	(kg)	(Kutu-Box)	(m ²)	(kg)
Porselen Karo / Porcelain Tiles	15x90	m ²	9	1,22	24,50	48	58,56	1.200



312910
15x90cm 6"x36"
Kahve / Brown



314910
15x90cm 6"x36"
Enna Kahve Motif / Enna Brown Motif



313910
15x90cm 6"x36"
Ponte Kahve Motif / Ponte Brown Motif



- Ürün fonu 16 farklı, motifler 4 farklı tasarımdan oluşur, bu nedenle kutular içerisinde farklı desenler çıkabilir.
- Since the product has 16 different faces and motifs have 4 different faces, you may receive different patterns in the boxes.

Ürün / Product	Ebat / Size (cm)	Birim / Unit (m ² /Ad/kg)	Kutu / Box			Palet / Pallet		
			(Ad-Pcs)	(m ²)	(kg)	(Kutu-Box)	(m ²)	(kg)
Porselen Karo / Porcelain Tiles	15x90	m ²	9	1,22	24,50	48	58,56	1.200



MALMO Gri / Grey



Sırlı Porselen Karo / Glazed Porcelain Tile



312912
15x90cm 6"x36"
Gri / Grey



314912
15x90cm 6"x36"
Enna Gri Motif / Enna Grey Motif



313912
15x90cm 6"x36"
Ponte Gri Motif / Ponte Grey Motif



- Ürün fonu 16 farklı, motifler 4 farklı tasarımdan oluşur, bu nedenle kutular içerisinde farklı desenler çıkabilir.
- Since the product has 16 different faces and motifs have 4 different faces, you may receive different patterns in the boxes.

Ürün / Product	Ebat / Size (cm)	Birim / Unit (m ² /Ad/kg)	Kutu / Box			Palet / Pallet		
			(Ad-Pcs)	(m ²)	(kg)	(Kutu-Box)	(m ²)	(kg)
Porselen Karo / Porcelain Tiles	15x90	m ²	9	1,22	24,50	48	58,56	1,200



WOOD DREAM Ceviz / Noce



Sırlı Porselen Karo / Glazed Porcelain Tile



310934
15x90cm 6"x36"
Ceviz / Noce



311912
15x90cm 6"x36"
İmola Ceviz Motif / Imola Noce Motif



311922
15x90cm 6"x36"
Terni Ceviz Motif / Terni Noce Motif



311932
15x90cm 6"x36"
Empoli Ceviz Motif / Empoli Noce Motif



- Ürün fonu 7 farklı, motifler 4 farklı tasarımdan oluşur, bu nedenle kutular içerisinde farklı desenler çıkabilir.
- Since the product has 7 different faces and motifs have 4 different faces, you may receive different patterns in the boxes.

Ürün / Product	Ebat / Size (cm)	Birim / Unit (m ² /Ad/kg)	(Ad-Pcs)	Kutu / Box		Palet / Pallet		
				(m ²)	(kg)	(Kutu-Box)	(m ²)	(kg)
Porselen Karo / Porcelain Tiles	15x90	m ²	9	1,22	24,50	48	58,56	1,200



WOOD DREAM Açık Gri / Light Grey



Sırlı Porselen Karo / Glazed Porcelain Tile



310931
15x90cm 6"x36"
Açık Gri / Light Grey

BEL 4



311913
15x90cm 6"x36"
İmola Açık Gri Motif / Imola Light Grey Motif

BEL 3



311923
15x90cm 6"x36"
Terni Açık Gri Motif / Terni Light Grey Motif

BEL 3



311933
15x90cm 6"x36"
Empoli Açık Gri Motif / Empoli Light Grey Motif

BEL 3

- Ürün fonu 7 farklı, motifler 4 farklı tasarımdan oluşur, bu nedenle kutular içerisinden farklı desenler çıkabilir.
- Since the product has 7 different faces and motifs have 4 different faces, you may receive different patterns in the boxes.

Ürün / Product	Ebat / Size (cm)	Birim / Unit (m ² /Ad/kg)	(Ad-Pcs)	Kutu / Box		Palet / Pallet		
				(m ²)	(kg)	(Kutu-Box)	(m ²)	(kg)
Porselen Karo / Porcelain Tiles	15x90	m ²	9	1,22	24,50	48	58,56	1,200



WOOD DREAM Gri / Grey



Sırlı Porselen Karo / Glazed Porcelain Tile



310932
15x90cm 6"x36"
Gri / Grey



311914
15x90cm 6"x36"
İmola Gri Motif / Imola Grey Motif



311924
15x90cm 6"x36"
Terni Gri Motif / Terni Grey Motif



311934
15x90cm 6"x36"
Empoli Gri Motif / Empoli Grey Motif



* Ürün fonu 7 farklı, motifler 4 farklı tasarımdan oluşur, bu nedenle kutular içerisinde farklı desenler çıkabilir.

* Since the product has 7 different faces and motifs have 4 different faces, you may receive different patterns in the boxes.

Ürün / Product	Ebat / Size (cm)	Birim / Unit (m ² /Ad/kg)	(Ad-Pcs)	Kutu / Box		Palet / Pallet		
				(m ²)	(kg)	(Kutu-Box)	(m ²)	(kg)
Porselen Karo / Porcelain Tiles	15x90	m ²	9	1,22	24,50	48	58,56	1,200



WOOD DREAM Badem / Almond



Sırlı Porselen Karo / Glazed Porcelain Tile



310933
15x90cm 6"x36"
Badem / Almond



311911
15x90cm 6"x36"
İmola Badem Motif / Imola Almond Motif



311921
15x90cm 6"x36"
Terni Badem Motif / Terni Almond Motif



311931
15x90cm 6"x36"
Empoli Badem Motif / Empoli Almond Motif



- Ürün fonu 7 farklı, motifler 4 farklı tasarımdan oluşur, bu nedenle kutular içerisinden farklı desenler çıkabilir.
- Since the product has 7 different faces and motifs have 4 different faces, you may receive different patterns in the boxes.

Ürün / Product	Ebat / Size (cm)	Birim / Unit (m ² /Ad/kg)	Kutu / Box			Palet / Pallet		
			(Ad-Pcs)	(m ²)	(kg)	(Kutu-Box)	(m ²)	(kg)
Porselen Karo / Porcelain Tiles	15x90	m ²	9	1,22	24,50	48	58,56	1,200



316912
15x90cm 6"x36"
Bej / Beige



316913
15x90cm 6"x36"
Gri / Grey



316911
15x90cm 6"x36"
Nero / Nero



- Ürün fonu 10 farklı tasarımdan oluşur, bu nedenle kutular içerisinde farklı desenler çıkabilir.
- Since the product has 10 different faces, you may receive different patterns in the boxes.

Ürün / Product	Ebat / Size (cm)	Birim / Unit (m ² /Ad/kg)	(Ad-Pcs)	Kutu / Box		Palet / Pallet		
				(m ²)	(kg)	(Kutu-Box)	(m ²)	(kg)
Porselen Karo / Porcelain Tiles	15x90	m ²	9	1,22	24,50	48	58,56	1,200

MAT VE PARLAK YÜZEYLERDE MÜKEMMEL UYUM

PERFECT HARMONY OF MATT & GLOSSY SURFACES

Modern ve estetik tasarım gücünü sadelikten alır. Duvar karolarımız, renk ve yüzeylerdeki harmoniyi yakalayarak eşsiz mekanlar yaratmak üzere tasarlanmıştır. Rektifiye edilmiş, 30x90cm ebatlardaki yeni portföyümüz ile üç boyutlu rölyef ve tekstil dokuları mat ve parlak seçenekler ile uygulayabilirsiniz.

Akışkan mermer damarların etkisi ile çarpıcı, canlı renkleri ile cesur, minimal tonları ile derinlik sahibi mekanlar için...

Modern & aesthetic design takes its ground from simplicity. Our Wall tiles are designed to create unique spaces with excellent harmony of matt and glossy surfaces. These matt and glossy surfaces can be practiced by 3D reliefs and textile patterns thanks to our new product portfolio, rectified 30x90cm wall tiles.

Fluid marble grains for attractive, vivid colors for bold, minimal shades for sophisticated spaces...



SILVER CALACATTA

30x90cm 12"x36"

50x50cm 20"x20"



9

198952
30x90 cm / 12"x36"
Silver Calacatta Glossy
Silver Calacatta Glossy



9

198960
30x90 cm / 12"x36"
Silver Calacatta Wave Glossy
Silver Calacatta Wave Glossy



m

198953
30x90 cm / 12"x36"
Silver Calacatta Matt
Silver Calacatta Matt



m

198961
30x90 cm / 12"x36"
Silver Calacatta Wave Matt
Silver Calacatta Wave Matt



9

195952
50x50 cm / 20"x20"
Silver Calacatta Glossy
Silver Calacatta Glossy

Sırlı Porselen Karo / Glazed Porcelain Tile

Ürün / Product	Ebat / Size (cm)	Birim / Unit (m ² /Ad/kg)	Kutu / Box			Palet / Pallet		
			(Ad-Pcs)	(m ²)	(kg)	(Kutu-Box)	(m ²)	(kg)
Duvar / Wall	30x90	m ²	7	1,89	33	28	52,92	930
Porselen Karo / Porcelain Tiles	50x50	m ²	7	1,75	32,50	24	42	800



SABBIA

30x90cm 12"x36"



60x60cm 24"x24"



495901
30x90 cm / 12"x36"
Ekru / Ecreu



495902
30x90 cm / 12"x36"
Kahve / Brown



495911
30x90 cm / 12"x36"
Petek Motif / Petek Motif



495920
60x60 cm / 24"x24"
Ekru / Ecreu

Sırlı Porselen Karo / Glazed Porcelain Tile



495921
60x60 cm / 24"x24"
Kahve / Brown

Sırlı Porselen Karo / Glazed Porcelain Tile

Ürün / Product	Ebat / Size (cm)	Birim / Unit (m ² /Ad/kg)	Kutu / Box			Palet / Pallet		
			(Ad-Pcs)	(m ²)	(kg)	(Kutu-Box)	(m ²)	(kg)
Duvar / Wall	30x90	m ²	7	1,89	33	28	52,92	930
Porselen Karo / Porcelain Tiles	60x60	m ²	4	1,44	33	32	46,08	1,020



POUDRE

30x90cm 12"x36"



60x60cm 24"x24"



(m)

493901
30x90 cm / 12"x36"
Krem / Cream



(m)

493903
30x90 cm / 12"x36"
Açık Gri / Light Grey



(m)

493904
30x90 cm / 12"x36"
Gri / Grey



(9)

493911
30x90 cm / 12"x36"
Diagon Colormix Motif
Diagon Colormix Motif



(m)

494601
60x60 cm / 24"x24"
Krem / Cream

Sırlı Porselen Karo / Glazed Porcelain Tile



(m)

494602
60x60 cm / 24"x24"
Açık Gri / Light Grey

Sırlı Porselen Karo / Glazed Porcelain Tile

Ürün / Product	Ebat / Size (cm)	Birim / Unit (m ² /Ad/kg)	Kutu / Box			Palet / Pallet		
			(Ad-Pcs)	(m ²)	(kg)	(Kutu-Box)	(m ²)	(kg)
Duvar / Wall	30x90	m ²	7	1,89	33	28	52,92	930
Porselen Karo / Porcelain Tiles	60x60	m ²	4	1,44	33	32	46,08	1,020



530901
30x90 cm / 12"x36"
Glossy Beyaz / Glossy White



531911
30x90 cm / 12"x36"
Glossy Wave Beyaz
Glossy Wave White



531921
30x90 cm / 12"x36"
Glossy Pesce Beyaz
Glossy Pesce White



531931
30x90 cm / 12"x36"
Glossy Diagon Beyaz
Glossy Diagon White



530902
30x90 cm / 12"x36"
Glossy Siyah / Glossy Black



531912
30x90 cm / 12"x36"
Glossy Wave Siyah
Glossy Wave Black



531922
30x90 cm / 12"x36"
Glossy Pesce Siyah
Glossy Pesce Black



531932
30x90 cm / 12"x36"
Glossy Diagon Siyah
Glossy Diagon Black

Ürün / Product	Ebat / Size (cm)	Birim / Unit (m ² /Ad/kg)	Kutu / Box			Palet / Pallet		
			(Ad-Pcs)	(m ²)	(kg)	(Kutu-Box)	(m ²)	(kg)
Duvar / Wall	30x90	m ²	7	1,89	33	28	52,92	930



MATT



Duvar Karosu / Wall Tile



536901
30x90 cm / 12"x36"
Matt Beyaz / Matt White



537911
30x90 cm / 12"x36"
Matt Wave Beyaz
Matt Wave White



537921
30x90 cm / 12"x36"
Matt Pesce Beyaz
Matt Pesce White



537931
30x90 cm / 12"x36"
Matt Diagon Beyaz
Matt Diagon White



536902
30x90 cm / 12"x36"
Matt Siyah / Matt Black



537912
30x90 cm / 12"x36"
Matt Wave Siyah
Matt Wave Black



537922
30x90 cm / 12"x36"
Matt Pesce Siyah
Matt Pesce Black



537932
30x90 cm / 12"x36"
Matt Diagon Siyah
Matt Diagon Black

Ürün / Product	Ebat / Size (cm)	Birim / Unit (m ² /Ad/kg)	Kutu / Box			Palet / Pallet		
			(Ad-Pcs)	(m ²)	(kg)	(Kutu-Box)	(m ²)	(kg)
Duvar / Wall	30x90	m ²	7	1,89	33	28	52,92	930



800302
30x30 cm / 12"x12"
Beyaz / White



800301



800332
30x30 cm / 12"x12"
Açık Gri / Light Grey



800331



800322
30x30 cm / 12"x12"
Siyah / Black



800321



SERENA Autumn Motif



800342
30x30 cm / 12"x12"
Autumn (1)



800341



800342
30x30 cm / 12"x12"
Autumn (2)



800341



800342
30x30 cm / 12"x12"
Autumn (3)



800341



800342
30x30 cm / 12"x12"
Autumn (4)



800341



800342
30x30 cm / 12"x12"
Autumn (5)



800341



800342
30x30 cm / 12"x12"
Autumn (6)



800341



- Autumn Motif 6 farklı tasarımdan oluşur, bu nedenle kutular içerisinde farklı desenler çıkabilir.
- Since the Autumn motif has 6 different faces, you may receive different patterns in the boxes.

Ürün / Product	Ebat / Size (cm)	Birim / Unit (m ² /Ad/kg)	Kutu / Box			Palet / Pallet		
			(Ad-Pcs)	(m ²)	(kg)	(Kutu-Box)	(m ²)	(kg)
Duvar / Wall	30x30	m ²	6	0,54	8	68	36,72	575
Motif / Motif	30x30	m ²	6	0,54	8	34	18,36	290



800302
30x30 cm / 12"x12"
Beyaz / White



800301



800332
30x30 cm / 12"x12"
Açık Gri / Light Grey



800331



800322
30x30 cm / 12"x12"
Siyah / Black



800321



SERENA Spring Motif



800312
30x30 cm / 12"x12"
Spring (1)



800311



800312
30x30 cm / 12"x12"
Spring (2)



800311



800312
30x30 cm / 12"x12"
Spring (3)



800311



800342
30x30 cm / 12"x12"
Spring (4)



800311



800312
30x30 cm / 12"x12"
Spring (5)



800311



800312
30x30 cm / 12"x12"
Spring (6)



800311



- Spring Motif 6 farklı tasarımdan oluşur, bu nedenle kutular içerisinde farklı desenler çıkabilir.
- Since the Spring motif has 6 different faces, you may receive different patterns in the boxes.

Ürün / Product	Ebat / Size (cm)	Birim / Unit (m ² /Ad/kg)	Kutu / Box			Palet / Pallet		
			(Ad-Pcs)	(m ²)	(kg)	(Kutu-Box)	(m ²)	(kg)
Duvar / Wall	30x30	m ²	6	0,54	8	68	36,72	575
Motif / Motif	30x30	m ²	6	0,54	8	34	18,36	290



800302
30x30 cm / 12"x12"
Beyaz / White



800301



800332
30x30 cm / 12"x12"
Açık Gri / Light Grey



800331



800322
30x30 cm / 12"x12"
Siyah / Black



800321



SERENA İstanbul Motif

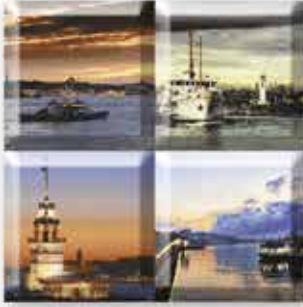

800352
30x30 cm / 12"x12"
İstanbul (1)



800352
30x30 cm / 12"x12"
İstanbul (2)



800352
30x30 cm / 12"x12"
İstanbul (3)



800352
30x30 cm / 12"x12"
İstanbul (4)



800352
30x30 cm / 12"x12"
İstanbul (5)



- İstanbul motif 5 farklı tasarımdan oluşur, bu nedenle kutular içerisinde farklı desenler çıkabilir.
- Since the İstanbul motif has 5 different faces, you may receive different patterns in the boxes.

Ürün / Product	Ebat / Size (cm)	Birim / Unit (m ² /Ad/kg)	Kutu / Box			Palet / Pallet		
			(Ad-Pcs)	(m ²)	(kg)	(Kutu-Box)	(m ²)	(kg)
Duvar / Wall	30x30	m ²	6	0,54	8	68	36,72	575
Motif / Motif	30x30	m ²	6	0,54	8	34	18,36	290



Duvar Karosu / Wall Tile



880111
10x20 cm / 4"x8"
Beyaz / White



880110
10x20 cm / 4"x8"
Bej / Beige



880114
10x20 cm / 4"x8"
Gri / Grey



880115
10x20 cm / 4"x8"
Kırmızı / Red



880113
10x20 cm / 4"x8"
Zümrüt Yeşil / Emerald



880112
10x20 cm / 4"x8"
Çimen Yeşil / Grass Green



880116
10x20 cm / 4"x8"
Siyah / Black

Ürün / Product	Ebat / Size (cm)	Birim / Unit (m ² /Ad/kg)	Kutu / Box		Palet / Pallet			
			(Ad-Pcs)	(m ²)	(Kutu-Box)	(m ²)	(kg)	
Duvar / Wall	10x20	m ²	40	0,8	10	75	60	790

DOĐAL TAŐ ETKİSİ

NATURAL CONCRETE EFFECT

Hem iç hem de dış mekan kullanımında betonun modern ve doğal etkisini yaşamak isteyenlere özel... Ticari alanlarda ve konutlarda rahatlıkla kullanılabilen beton dokulu ürünler kullanıldıkları alanlarda farklı bir görünüm yaratıyor. Tasarımcıların ilk tercihleri arasında yer alan doğal görünüm, dijital teknoloji kullanılarak porselene yansıyor. Yaya trafiğinin yoğun olduğu alanlarda uygulanabilirliği ve farklı kalınlıktaki üretimi ile döşemede de rahatlık sunuyor.

For those who would like to experience the modern and natural effect of concrete in indoors and outdoors... Suitable for both commercial and residential usage, concrete textured porcelain creates a unique touch where it is tiled. Utilizing digital technology, the natural look that is always a favorite for designers, is reflected to porcelain. With being usable in high traffic areas, and with the two different thickness levels the product provides, can be practiced with ease...

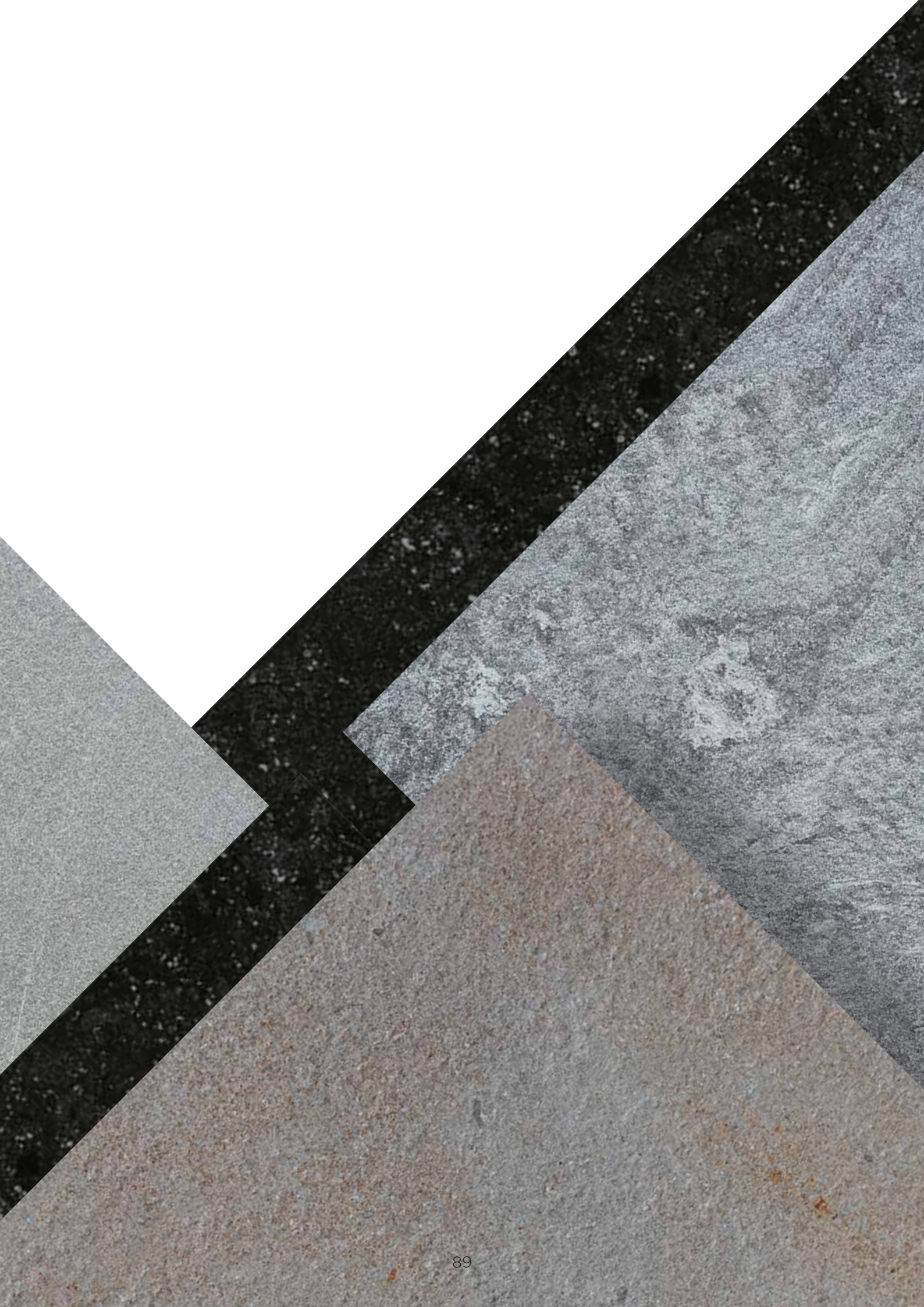



QUARZITE

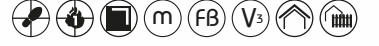

Porselen Karo / Porcelain Tile "UGL"



911620 20 mm
60x60 cm / 24" x 24"

- TS-EN 14411 standardına göre aşınma < 175 mm³ değerine uygun olarak üretilir.
- Abrasion resistance value of porcelain tile is < 175 mm³ according to TS-EN 14411.

RESOLUTE



Porselen Karo / Porcelain Tile "UGL"



909620 20 mm
60x60 cm / 24" x 24"
Gri / Grey



909621 20 mm
60x60 cm / 24" x 24"
Dark Gri / Dark Grey

- TS-EN 14411 standardına göre aşınma < 175 mm³ değerine uygun olarak üretilir.
- Abrasion resistance value of porcelain tile is < 175 mm³ according to TS-EN 14411.

Ürün / Product	Ebat / Size (cm)	Birim / Unit (m ² /Ad/kg)	(Ad-Pcs)	Kutu / Box		Palet / Pallet			
				(m ²)	(kg)	(Kutu-Box)	(m ²)	(kg)	
Porselen Karo / Porcelain Tiles	20mm	60x60	m ²	2	0,72	17,2	30	21,6	1,050



HARDY

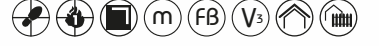

Porselen Karo / Porcelain Tile "UGL"



919610 20 mm
60x60 cm / 24" x 24"

- TS-EN 14411 standardına göre aşınma < 175 mm³ değerine uygun olarak üretilir.
- Abrasion resistance value of porcelain tile is < 175 mm³ according to TS-EN 14411.

BELGIUM STONE Antrasit / Anthracite



Porselen Karo / Porcelain Tile "UGL"



910620 20 mm
60x60 cm / 24" x 24"

- TS-EN 14411 standardına göre aşınma < 175 mm³ değerine uygun olarak üretilir.
- Abrasion resistance value of porcelain tile is < 175 mm³ according to TS-EN 14411.

Ürün / Product	Ebat / Size (cm)	Birim / Unit (m ² /Ad/kg)	Kutu / Box			Palet / Pallet			
			(Ad-Pcs)	(m ²)	(kg)	(Kutu-Box)	(m ²)	(kg)	
Porselen Karo / Porcelain Tiles	20mm	60x60	m ²	2	0,72	17,2	30	21,6	1,050



230902
60x60 cm / 24"x24"
Gri / Grey



230912
60x60 cm / 24"x24"
Carpette Gri Motif / Carpette Grey Motif



230901
60x60 cm / 24"x24"
Bej / Beige



230911
60x60 cm / 24"x24"
Carpette Bej Motif / Carpette Beige Motif



- Ürün fonu ve motifler 4 farklı tasarımdan oluşur, bu nedenle kutular içerisinde farklı desenler çıkabilir.
- Since the product and motifs have 4 different faces, you may receive different patterns in the boxes.

Ürün / Product	Ebat / Size (cm)	Birim / Unit (m ² /Ad/kg)	Kutu / Box		Palet / Pallet			
			(Ad-Pcs)	(m ²)	(kg)	(Kutu-Box)	(m ²)	(kg)
Porselen Karo / Porcelain Tiles	60x60	m ²	4	1,44	33	32	46,08	1,020



Sırlı Porselen Karo / Glazed Porcelain Tile



500501 (1)
50x50 cm / 20"x20"
Siyah-Beyaz / Black-White

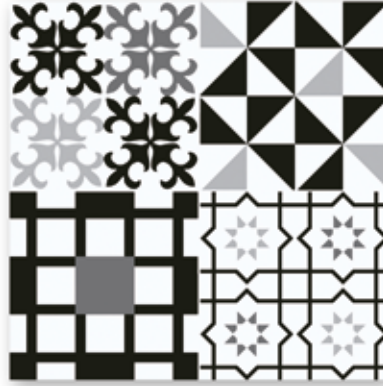

500501 (2)
50x50 cm / 20"x20"
Siyah-Beyaz / Black-White



500501 (3)
50x50 cm / 20"x20"
Siyah-Beyaz / Black-White



500501 (4)
50x50 cm / 20"x20"
Siyah-Beyaz / Black-White



500501 (5)
50x50 cm / 20"x20"
Siyah-Beyaz / Black-White



500501 (6)
50x50 cm / 20"x20"
Siyah-Beyaz / Black-White



500501 (7)
50x50 cm / 20"x20"
Siyah-Beyaz / Black-White



500501 (8)
50x50 cm / 20"x20"
Siyah-Beyaz / Black-White



500501 (9)
50x50 cm / 20"x20"
Siyah-Beyaz / Black-White



- Ürün fonu 16 farklı tasarımdan oluşur, bu nedenle kutular içerisinde farklı desenler çıkabilir.
- Since the product has 16 different faces, you may receive different patterns in the boxes.

Ürün / Product	Ebat / Size (cm)	Birim / Unit (m ² /Ad/kg)	Kutu / Box			Palet / Pallet		
			(Ad-Pcs)	(m ²)	(kg)	(Kutu-Box)	(m ²)	(kg)
Porselen Karo / Porcelain Tiles	50x50	m ²	7	1,75	32,50	24	42	800

TEKNİK BİLGİLER VE ÖZELLİKLER / TECHNICAL INFORMATION & CHARACTERISTICS

SEMBOLLER / SYMBOLS



Yer Karosu
Floor Tile



Duvar Karosu
Wall Tile



Tek Pişirim
Single Firing



Çift Pişirim
Double Firing



Üç Pişirim
Third Firing



Parlak
Glossy



Mat
Matt



Lappato



**Full
Lappato**



**High
Glossy**



Naturel
Natural



**Semi
Lappato**



Nanotech



Renk Tonu Değişim
Color Shade Variation



Kaymazlık
Slipping Rate



Aşınmaya Dayanıklılık
Abrasion Resistance



Renkli Masse
Colored Body



Full Body



Rektifiyesiz
Unrectified



Rektifiyeli
Rectified



İç Mekan
Indoor



Dış Mekan
Outdoor



Yüzey Bitişi / Surface Treatments

High Glossy

Porselen karoların özel bir sır ile kaplanması ile elde edilen yüksek parlaklıktaki ürünlerdir.
They are highly lustrous porcelain tiles covered with a special glaze.

Mat / Matt

Yüzeyleri mat dokulu sır ile kaplanmış, yüzeyi işlem görmemiş karolardır.
They are natural tiles whose surfaces are glazed with matt glaze.

Parlak / Glossy

Yüzeyleri parlak dokulu sır ile kaplanmış, yüzeyi işlem görmemiş karolardır.
They are natural tiles whose surfaces are glazed with glossy glaze.

Lappato / Semi polished

Özel cam tanecikleri ile kaplanıp pişirilmiş karoların parlatılması ile elde edilen yarı parlak yarı mat yüzeylerdir.
They are semi-polished surfaces manufactured via the lustering of tiles after covering them with special glass grains/glass forming minerals then firing them.

Rölyef / Relief

Karoların şekillendirilmesi sırasında kalıplar vasıtası ile elde edilen yüzey dokularıdır.
They are the surface textures which are produced by moulds at the time of tile-sculpting.

Full Lappato

Özel sır ile kaplanmış karoların ince bir parlatma işlemine tabi tutulması ile elde edilen karolardır.
They are type of tiles produced by fine polishing of tiles covered with a special glaze.

Aşınmaya Dayanıklılık / Abrasion Resistance

P.E.I. - 1 Duvarlar ile banyo ve yatak odası zeminleri için uygundur. / Suitable for walls, bathroom and bedroom floors.

P.E.I. - 2 Konutlar gibi yaya trafiği az olan zeminler için uygundur. / Suitable for light traffic environments like the floor of a house.

P.E.I. - 3 Antre, koridor gibi giriş çıkışı fazla olan zeminler için uygundur. / Suitable for moderately heavy traffic area floors, like the entrance and the corridor.

P.E.I. - 4 Mağaza, restoran gibi yaya trafiğine daha fazla maruz kalan zeminler için uygundur. / Suitable for heavy traffic area floors like restaurants, shopping stores. etc.

P.E.I. - 5 Mağaza, otel, restoran, ofis, okul, teşhir salonu gibi yaya trafiğine fazla maruz kalan zeminler için uygundur. / Suitable for floors subject to heavy foot traffic and abrasion, such as shops, hotels, restaurants, offices, schools, exhibition halls, etc.

Renk Tonu Değişim Skalası / Color Shade Variation Guide

V1 DÜŞÜK UNIFORM	Desen ve renk tonu farklılıkları düşük seviyededir. The least amount of shade and texture variation attainable in naturally fired clay products.
V2 ORTA SLIGHT	Desen ve renk tonu farklılıkları orta seviyededir. Light to moderate shade and texture variation within each box.
V3 YÜKSEK HIGH	Desen ve renk tonu farklılıkları yüksek seviyededir. High shade and texture variation within each box.
V4 DEĞİŞKEN RANDOM	Desen ve renk tonu farklılıkları en üst seviyededir. Very high shade and texture variation within each box.

Kenar Bitişi / Edge Treatments

Rektifiyeli (Ebatlanmış) / Rectified

Karoların kenarlarının tıraşlanarak 1mm'den daha düşük sapma olacak şekilde aynı boyuta (tek kalibrasyona) getirilmesi işlemidir. Bu sayede ürünler daha küçük derz aralıkları ile döşenebilir ve görsel kalite artar.

It is the process of cutting the edges of tiles to same size with the deviation of less than 1 mm. As a result, these tiles can be laid with a narrower grout joint. Moreover, visual quality increases.

Pahlı / Chamfered

Karoların ebatlamadan sonra kenarlarındaki keskinliğin yuvarlatılması işlemidir. Bu sayede kullanıcıya verebileceği zarar engellenmiş olur. Aynı zamanda kenar kırılmaları da önlenir.

The process of rounding of the edges of tiles after the tile sizing. This process prevents damage to the user. At the same time it prevents edge breaks.



TEKNİK ÖZELLİKLER / TECHNICAL CHARACTERISTICS

Duvar Karosu Teknik Özellikleri Wall Tiles Technical Characteristics

Teknik Özellikler / Technical Characteristics	Türk & Avrupa Standardı Turkish & European Standart (TS - EN 14411 BIII)	Seramiksan Sırlı & Sırsız Duvar Karoları Glazed & Unglazed Wall Tiles	TS - EN
Ebat Toleransı Uzunluk ve Genişlik / Deviations from Dimensions Length and Width (L=cm, S=cm ²)	N (Nominal Size) ≥ 15 cm = ± 0.5, ± 2 mm	N (Nominal Size) ≥ 15 cm = ± 0.5, ± 2 mm	ISO 10545 - 2
Ebat Toleransı Kalınlık / Deviations from Dimensions Thickness (%)	% 10, ± 0.5 mm	% 10, ± 0.5 mm	ISO 10545 - 2
Gönyeden Sapma / Rectangularity	Max. ± % 0.5, ± 2 mm	Max. ± % 0.3, ± 2 mm	ISO 10545 - 2
Kenar Düzgünlüğü / Straightness of Sides	Max. ± % 0.3, ± 1.5 mm	Max. ± % 0.3, ± 1.5 mm	ISO 10545 - 2
Yüzey Düzgünlüğü / Surface Flatness	+ % 0.5 - % 0.3, ± 2 mm - 1.5 mm	+ % 0.5 - % 0.3, ± 2 mm - 1.5 mm	ISO 10545 - 2
Yüzey Kalitesi / Surface Quality	Max. % 5 Kusurlu / % 5 Defective	Uygundur / Affirmative	ISO 10545 - 2
Su Emme / Water Absorption	Ortalama %10, eğer %20'yi geçerse üretici tarafından belirtilecektir. Ave. > 10 %, when the value exceeds %20 this shall be indicated by the manufacturer.	Ort / Ave. %16	ISO 10545 - 3
Eğilme Dayanımı / Bending Strength (N/mm ²)	Kalınlık / Thickness < 7.5 mm, Min. 15 Kalınlık / Thickness > 7.5 mm, Min. 12	Min. 20	ISO 10545 - 4
Isı Genleşme Katsayısı / Linear Thermal Expansion Coefficient	Üretici beyan eder. Declared valve.	< 9x10 ⁻⁶ K ⁻¹	ISO 10545 - 8
Isı Şokuna Dayanıklılık / Resistance to Thermal Shock	İstenir / Required	Uygundur / Affirmative	ISO 10545 - 9
Sırlı Karolarda Çatlama Dayanımı / Cracking Resistance in Glazed Tiles	İstenir / Required	Uygundur / Affirmative	ISO 10545 - 11
Asit ve Alkaliye Dayanıklılık Resistance to Acids and Alkalies	Üretici beyan eder. Declared valve.	Min. GB	ISO 10545 - 13
Evsel Temizlik Maddelerine ve Yüzme Havuzu Tuzlarına Dayanıklılık Resistance to Household Chemicals and Swimming Pool Salts	Min. GB	Min. GB	ISO 10545 - 13
Lekelemeye Dayanıklılık / Resistance to Staining	Min. Sınıf 3 / Min. Class 3	Min. Sınıf 3 / Min. Class 3	ISO 10545 - 14

Yer Karosu Teknik Özellikleri Floor Tiles Technical Characteristics

Teknik Özellikler / Technical Characteristics	Türk & Avrupa Standardı Turkish & European Standart (TS - EN 14411 BIIb)	Seramiksan Sırlı Yer Karoları Glazed Floor Tiles	TS - EN
Ebat Toleransı Uzunluk ve Genişlik / Deviations from Dimensions Length and Width (L=cm, S=cm ²)	N (Nominal Size) ≥ 15 cm = ± 0.6, ± 2 mm	N (Nominal Size) ≥ 15 cm = ± 0.6, ± 2 mm	ISO 10545 - 2
Ebat Toleransı Kalınlık / Deviations from Dimensions Thickness (%)	± % 5, ± 0.5 mm	± % 5, ± 0.5 mm	ISO 10545 - 2
Gönyeden Sapma / Rectangularity	% 0.5, ± 2 mm	± % 0.4, ± 2 mm	ISO 10545 - 2
Kenar Düzgünlüğü / Straightness of Sides	± % 0.5, ± 1.5 mm	± % 0.3, ± 1.5 mm	ISO 10545 - 2
Yüzey Kalitesi / Surface Quality	Max. % 5 Kusurlu / % 5 Defective	Uygundur / Affirmative	ISO 10545 - 2
Düzlemden Sapma / Surface Flatness	± % 0.5, ± 2 mm	± % 0.5, ± 2 mm	ISO 10545 - 2
Su Emme Yer Karosu / Water Absorption Floor Tiles	Max. % 3	Max. % 3	ISO 10545 - 3
Eğilme Dayanımı Yer Karosu / Bending Strength Floor Tiles (N/mm ²)	Min. 30	Min. 35	ISO 10545 - 4
Aşınmaya Dayanıklılık Yer Karosu / Abrasion Resistance Floor Tiles	Üretici beyan eder. Abrasion class and cycles passed.	Katalog içerisinde beyan edilmiştir. Indicated in the catalogue.	ISO 10545 - 7
Isı Genleşme Katsayısı / Linear Thermal Expansion Coefficient	Üretici beyan eder. Declared valve.	< 9x10 ⁻⁶ K ⁻¹	ISO 10545 - 8
Isı Şokuna Dayanıklılık / Resistance to Thermal Shock	İstenir / Required	Uygundur / Affirmative	ISO 10545 - 9
Çatlama Dayanımı / Cracking Resistance Tiles	İstenir / Required	Uygundur / Affirmative	ISO 10545 - 11
Asit ve Alkaliye Dayanıklılık Resistance to Acids and Alkalies	Üretici beyan eder. Declared valve.	Uygundur / Affirmative	ISO 10545 - 13
Evsel Temizlik Maddelerine ve Yüzme Havuzu Tuzlarına Dayanıklılık Sırlı Karolar Resistance to Household Chemicals and Swimming Pool Salts Glazed Tiles	Min. GB	Min. GB	ISO 10545 - 13
Evsel Temizlik Maddelerine ve Yüzme Havuzu Tuzlarına Dayanıklılık Sırsız Karolar Resistance to Household Chemicals and Swimming Pool Salts Unglazed Tiles	Min. UB	Min. UB	ISO 10545 - 13
Lekelemeye Dayanıklılık / Resistance to Staining	Min. Sınıf 3 / Min. Class 3	Min. Sınıf 3 / Min. Class 3	ISO 10545 - 14

Porselen Karo Teknik Özellikleri

Porcelain Tiles Technical Characteristics

Teknik Özellikler / Technical Characteristics	Türk & Avrupa Standardı Turkish & European Standart (TS - EN 14411 Bla)	Seramiksın Sırlı & Sırsız Porselen Karolar Glazed & Unglazed Porcelain Tiles	TS - EN
Ebat Toleransı Uzunluk ve Genişlik Deviations from Dimensions Length and Width (L=cm, S=cm ²)	N (Nominal Size) ≥ 15 cm = ± % 0,6, ± 2 mm	N (Nominal Size) ≥ 15 cm = ± % 0,6, ± 2 mm	ISO 10545 - 2
Ebat Toleransı Kalınlık / Deviations from Dimensions Thickness (%)	± % 5, ± 0,5 mm	± % 5, ± 0,5 mm	ISO 10545 - 2
Gönyeden Sapma / Rectangularity	% 0,5, ± 2 mm	± % 0,4, ± 2 mm	ISO 10545 - 2
Kenar Düzgünlüğü / Straightness of Sides	± % 0,5, ± 1,5 mm	± % 0,3, ± 1,5 mm	ISO 10545 - 2
Yüzey Kalitesi / Surface Quality	Max. % 5 Kusurlu / % 5 Defective	Uygundur / Affirmative	ISO 10545 - 2
Düzlemden Sapma / Surface Flatness	% 0,5	% 0,3	ISO 10545 - 2
Su Emme Sırlı Porselen / Water Absorption Glazed Porcelain Tile	Max. % 0,5	Max. % 0,5	ISO 10545 - 3
Su Emme Sırsız Porselen / Water Absorption Unglazed Porcelain Tile	Max. % 0,5	Max. % 0,05	ISO 10545 - 3
Eğilme Dayanımı Sırlı Porselen Bending Strength Glazed Porcelain Tiles (N/mm ²)	35	40	ISO 10545 - 4
Eğilme Dayanımı Sırsız Porselen Bending Strength Unglazed Porcelain Tiles (N/mm ²)	35	45	ISO 10545 - 4
Aşınmaya Dayanıklılık Sırlı Porselen Abrasion Resistance Glazed Porcelain Tiles	Üretici beyan eder. Abrasion class and cycles passed.	Katalog içerisinde beyan edilmiştir. Indicated in the catalogue.	ISO 10545 - 7
Aşınmaya Dayanıklılık Sırsız Porselen Abrasion Resistance Unglazed Porcelain Tiles	Max. 175 mm ³	Max. 175 mm ³	ISO 10545 - 7
Isıl Genleşme Katsayısı / Linear Thermal Expansion Coefficient	Üretici beyan eder. Declared value.	< 90x10 ⁻⁷ K ⁻¹	ISO 10545 - 8
Isı Şokuna Dayanıklılık / Resistance to Thermal Shock	İstenir / Required	Uygundur / Affirmative	ISO 10545 - 9
Çatlama Dayanımı / Cracking Resistance Tiles	İstenir / Required	Uygundur / Affirmative	ISO 10545 - 11
"Asit ve Alkaliye Dayanıklılık / Resistance to Acids and Alkalies"	Üretici beyan eder. Declared value.	Uygundur / Affirmative	ISO 10545 - 13
"Evsel Temizlik Maddelerine ve Yüzme Havuzu Tuzlarına Dayanıklılık Sırlı Karolar Resistance to Household Chemicals and Swimming Pool Salts Glazed Tiles"	Min. GB	Min. GB	ISO 10545 - 13
"Evsel Temizlik Maddelerine ve Yüzme Havuzu Tuzlarına Dayanıklılık Sırsız Karolar Resistance to Household Chemicals and Swimming Pool Salts Unglazed Tiles"	Min. UB	Min. UB	ISO 10545 - 13
Lekelenmeye Dayanıklılık / Resistance to Staining	Min. Sınıf 3 / Min. Class 3	Min. Sınıf 3 / Min. Class 3	ISO 10545 - 14

Tablolarda belirtilen toplam palet ağırlıkları, üretim teknolojisi, kullanılan ambalaj malzemeleri ve paletlemeden kaynaklanan değişikliklerden dolayı farklılıklar arz edebilir.

* Teknik porselenlerde su emme <%0,05 ve aşınma değeri <175 mm³

Seramiklerin yanında görülen numaralar, Türk ve Avrupa Standardı TS-EN 10545-7'ye göre yüzey aşınma dayanım sınıfını belirler.
The numbers beside ceramic tiles indicate the abrasion resistance of the ceramic surface according to Turkish and European Standart TS-EN 10545-7

Seramiksın, bu katalogda belirtilen ve hiç biri yasal olarak bağlayıcı olmayan bilgi ve teknik özellikleri, dilediği herhangi bir anda ve önceden haber vermeden değiştirme hakkını saklı tutar. Ağırlık, renk ve boyutlar, seramik fırınlama işleminden kaynaklanan normal sınırlar içinde değişiklik gösterebilir. Katalogumuzda belirtilen renkler ürünlerimizin gerçek renklerini yansıtmayabilir.

Seramiksın, reserves the right at any time and without prior notice to change the information and technical characteristics given in this catalog, none of which are to be considered legally binding. Weights, colors and dimensions are subjects to the normal variations resulting from the ceramic firing process. The colors that are seen in our catalog may not reflect the original colours of our products.



PAKETLEME DETAYLARI / PACKAGING DETAILS

Duvar Karosu / Wall Tiles	Ebat Size		Adet/Kutu Pcs/Box	m ² /Kutu Sqm/Box	Kutu/Palet Box/Pal.	m ² /Palet Sqm/Pal.	Kg (Brüt)/Palet Kgs (Gross)/Pal.
	15x15 cm	6"x6"	44	1	115	115	1130
	10x20 cm	4"x8"	40	0,8	75	60	790
	10x30 cm	4"x12"	33	1	60	60	940
	20x20 cm	8"x8"	25	1	72	72	1.070
	20x25 cm	8"x10"	25	1	100	100	1.200
	25x33 cm	10"x13"	12	1	75	75	1.040
	25x50 cm	10"x20"	11	1,38	54	74,52	1.000
	25x40 cm	10"x16"	14	1,4	54	75,6	1.100
	25x75 cm	10"x30"	7	1,31	24	31,44	700
	25x75 cm (Ebru)	10"x30"	6	1,13	26	29,38	600
	20x60 cm	8"x24"	8	0,96	54	51,84	800
	30x30 cm	12"x12"	6	0,54	68	36,72	575
	30x60 cm	12"x24"	8	1,44	40	57,60	820
	30x60 cm (Mosaico)	12"x24"	7	1,26	36	45,36	780

Yer Karosu / Floor Tiles	Ebat Size		Adet/Kutu Pcs/Box	m ² /Kutu Sqm/Box	Kutu/Palet Box/Pal.	m ² /Palet Sqm/Pal.	Kg (Brüt)/Palet Kgs (Gross)/Pal.
	20x20 cm	8"x8"	25	1	72	72	1.070
	33x33 cm	13"x13"	13	1,42	48	68,16	1.050
	30x60 cm	12"x24"	8	1,44	36	51,84	1.050
	40x40 cm	16"x16"	11	1,76	48	84,48	1.370

Porselen Karolar / Porcelain Tiles	Ebat Size		Adet/Kutu Pcs/Box	m ² /Kutu Sqm/Box	Kutu/Palet Box/Pal.	m ² /Palet Sqm/Pal.	Kg (Brüt)/Palet Kgs (Gross)/Pal.
	60x120	24"x48" S. Por. / G. Por. (F.Lap.)	2	1,44	29	41,76	1.080
	20x120	8"x48" S. Por. / G. Por.	4	0,96	36	34,56	850
	60x90	24"x36" S. Por. / G. Por. (F.Lap.)	2	1,08	40	43,20	1.120
	60x60	24"x24" S. Por. / G. Por. (F.Lap.)	4	1,44	30	43,20	1.140
	30x90	12"x36" S. Por. / G. Por. (F.Lap.)	4	1,08	44	47,52	1.260
	10x20	4"x8" S. Por. / G. Por. (F.Lap.)	40	0,8	84	67,2	1000
	12x24,5	4,9"x9,6" S. Por. / G. Por. (F.Lap.)	31	0,91	81	73,71	1.160
	15x90	6"x36" S. Por. / G. Por. (F.Lap.)	8	1,08	33	35,64	920
	30x90	12"x36" Dekor / Decor (F. Lap.)	4	1,08	44	47,52	1.250
	60x90	24"x36" S. Por. / G. Por. (Nat.)	2	1,08	40	43,20	1.120
	60x60	24"x24" S. Pors. / G. Por. (Nat.)	4	1,44	32	46,08	980
	30x90	12"x36" S. Por. / G. Por. (Nat.)	4	1,08	44	47,52	1.260
	15x90	6"x36" S. Por. / G. Por. (Nat.)	9	1,22	48	58,56	1.200
	15x60	6"x24" S. Por. / G. Por. (Nat.)	10	0,9	48	43,2	1.000
	30x90	12"x36" Dekor / Decor (Nat.)	4	1,08	44	47,52	1.250
	60x60	24"x24" S. Por. / G. Por.	4	1,44	30	43,20	1.060
	50x50	20"x20" S. Por. / G. Por.	7	1,75	24	42	800
	30x60	12"x24" S. Por. / G. Por.	7	1,26	32	40,32	1.070
	Teknik Porselen / Technical Porcelain						
30x30 cm	12"x12"	6	0,54	60	32,4	1000	



CO01201
Fayans ve Seramik Yapıştırma Harcı
Superadhesive Mortar For Wall & Floor Tiles
25kg Torba / Bag
48 Torba / Bags - Palet



CO01301 Beyaz
CO01302 Gri
Granit ve Seramik için Esnek
Yapıştırma Harcı
Flex Superadhesive Mortar for
Porcelain & Floor Tiles
25kg Torba / Bag
48 Torba / Bags - Palet



CO01202 Gri
CO01203 Beyaz
Granit Yapıştırma Harcı
Superadhesive Mortar For Porcelain Tiles
25kg Torba / Bag
48 Torba / Bags - Palet



CO01102 Beyaz
Derz Dolgu Malzemesi
Grout for Wall & Floor Ceramic Tiles
20kg Torba / Bag
48 Torba / Bags - Palet



CO00110 Beyaz
Derz Dolgu Malzemesi
Grout for Wall & Floor Ceramic Tiles
10kg Torba / Bag

- CO00111 Krem
- CO00112 Kanyon Bej
- CO00113 Anatolia Bej
- CO00114 Kahve
- CO00115 Gri
- CO00116 Kayrak Gri
- CO00117 Siyah
- CO00118 Assos Bej
- CO00119 Teos Gri
- CO00120 Granit Gri



CO00402 Gri
Granit Yapıştırma Harcı
Superadhesive Mortar For Porcelain Tiles
25kg Torba / Bag
48 Torba / Bags - Palet

BÖLGE SATIŞ YÖNETİCİLERİ

MARMARA BÖLGE VİTRİFİYE SATIŞ YÖNETİCİSİ

Tel: 0549 791 48 65

SAMSUN BÖLGE VİTRİFİYE SATIŞ YÖNETİCİSİ

Tel: 0549 727 23 64

İZMİR BÖLGE VİTRİFİYE SATIŞ YÖNETİCİSİ

Tel: 0533 129 82 18

ANKARA BÖLGE VİTRİFİYE SATIŞ YÖNETİCİSİ

Tel: 0533 594 66 40

ADANA BÖLGE VİTRİFİYE SATIŞ YÖNETİCİSİ

Tel: 0533 705 73 38

İZMİR I BÖLGE (Aydın, Denizli, İzmir, Manisa)

Tel: 0533 594 66 35

İZMİR II BÖLGE (Balıkesir, İzmir)

Tel: 0533 594 66 52

İZMİR III BÖLGE (İzmir, Manisa)

Tel: 0530 310 95 57

İZMİR IV BÖLGE (İzmir, Muğla)

Tel: 0533 594 66 53

İSTANBUL (AVRUPA) BÖLGE (Edirne, İstanbul(Avrupa), Kırklareli, Tekirdağ)

Tel: 0533 594 66 56

İSTANBUL (ANADOLU) BÖLGE (Bartın, Bolu, Düzce, İstanbul (Anadolu),

Karabük, Sakarya, Zonguldak)

Tel: 0533 594 66 58

BURSA I BÖLGE (Balıkesir, Bursa, Çanakkale)

Tel: 0533 594 66 55

BURSA II BÖLGE (Bursa, Bilecik, Yalova, Eskişehir, Kütahya, Uşak)

Tel: 0533 129 82 23

KONYA / ANTALYA BÖLGE (Afyon, Karaman, Konya, Uşak, Antalya, Burdur, Isparta)

Tel: 0533 129 82 19

ANKARA BÖLGE (Ankara, Çankırı, Kayseri, Kırıkkale, Kırşehir, Nevşehir)

Tel: 0533 594 66 48

ADANA BÖLGE (Adana, Antakya, Mersin, Osmaniye, Niğde, Aksaray)

Tel: 0533 594 66 41

GAZİANTEP BÖLGE (Gaziantep, Adıyaman, Kahramanmaraş, Malatya, Elazığ, Tunceli, Kilis)

Tel: 0533 594 66 44

SAMSUN BÖLGE (Amasya, Çorum, Giresun, Kastamonu, Samsun, Sinop, Ordu, Tokat, Sivas, Yozgat)

Tel: 0533 594 66 45

TRABZON BÖLGE (Artvin, Bayburt, Gümüşhane, Rize, Trabzon)

Tel: 0533 594 66 47

DİYARBAKIR BÖLGE (Diyarbakır, Batman, Bingöl, Bitlis, Hakkari, Mardin, Muş,

Siirt, Şanlıurfa, Şırnak, Van)

Tel: 0533 594 66 54

ERZURUM BÖLGE (Ardahan, Kars, Ağrı, Erzurum, Iğdır, Erzincan)

Tel: 0530 063 67 75

Kurumsal Müşteri ve Projeler Yöneticisi

Tel: 0533 594 66 59

Yapı Marketler Satış Yöneticisi

Tel: 0549 791 48 66



Fabrika / Factory
Organize Sanayi Bölgesi,
45401 Turgutlu-MANİSA/TÜRKİYE
T : +90 (236) 313 9613
F : +90 (236) 313 7764

info@seramiksan.com.tr export@seramiksan.com.tr
seramiksan.com.tr

www.grafisreklam.com.tr 09/17



facebook.com/
seramiksan



twitter.com/
seramiksan



instagram.com/
seramiksan

