

YENİ SERİLER

New Series

UNICERA 2017

İÇİNDEKİLER / INDEX

BELLA MARMİ SERIES

BLACK MARBLE	4-5
NAT. BLACK MARBLE	6
BERGAMA	7
EMPERADOR	8
VERDE ALPI	9
PARMA ROSSO	10
EPHESUS	11
LECCINO	12
CASTELO	13
TIVOLI DARK	14
TIVOLI LIGHT	15

ASIA	16-18
NEW ORLEANS	16-19
CALACATA MARMİ	20-21
MILANO	22-25
PHILADELPHIA	26-27
PERGE	28-30
PARADISE	31
BRECHA	32
GRANITO	33
KRIPTON	34-35
VENUS	36-37
ISTANBUL	38-39
WOOD DREAM	40-44
OSLO	45
MALMO	46-48
RIGA	49
STİL - VISTA	50
FORM	51
HERMES	52
BRICK - TRUVA	53
KRONOS	54
NEPAL - OLIMPOS	55
MONZA	56-57
LINEN	58-59
PARMA / ALBA	60
SERENA	61-63

Teknik Bilgiler ve Özellikler

Technical Information & Characteristics

Semboller / Symbols	64
Teknik Bilgiler / Technical Information	65
Teknik Özellikler / Technical Characteristics	66-67

Bella SERIES
Marmi





BLACK MARBLE

SİYAH/ BLACK



IGIART

Sırlı Porselen Karo
Glazed Porcelain Tile

Bella SERIES
Marmi

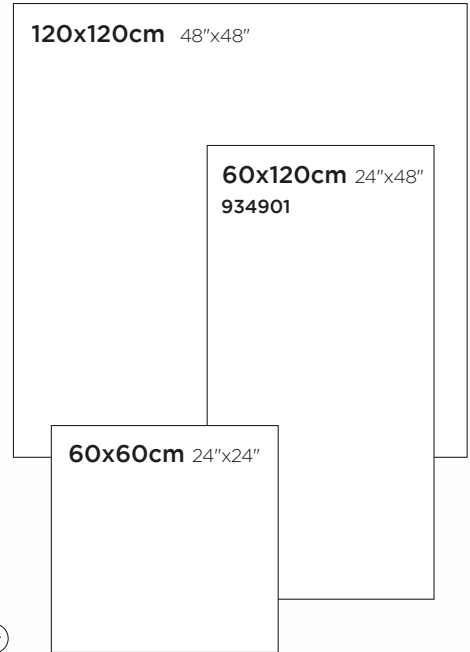



Ürün / Product	Ebat / Size (cm)	Birim / Unit (m ² /Ad/kg)	Kutu / Box			Palet / Pallet		
			(Ad-Pcs)	(m ²)	(kg)	(Kutu-Box)	(m ²)	(kg)
Porselen Karo / Porcelain Tiles	120x120							
	60x120	m ²	2	1,44	36,3	29	41,76	1,080
	60x60	m ²	4	1,44	33	30	43,2	1,020



NAT. BLACK MARBLE

SİYAH/ BLACK

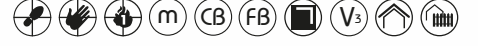

IGI ART

Sırsız Porselen Karo
Unglazed Porcelain Tile

Bella SERIES
Marmi

- NanoTech Granitler, TS-EN 14411 standardına göre aşınma < 175 mm³ değerine uygun olarak üretilir.
- Abrasion resistance value of Nanotech granites is < 175 mm³ according to TS-EN 14411.

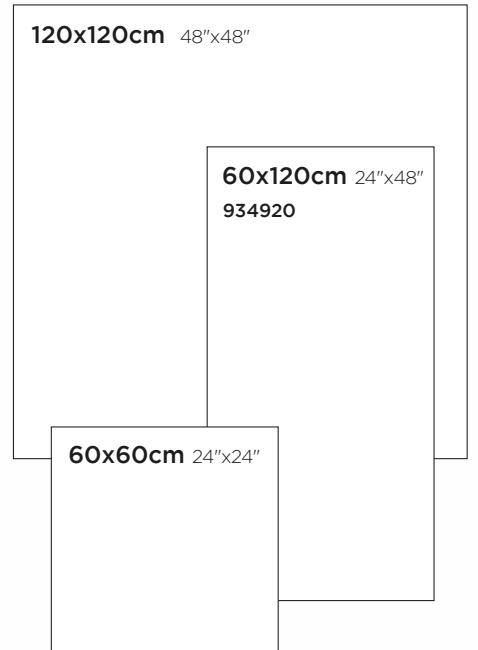

BERGAMA



DIGIART

Sırlı Porselen Karo
Glazed Porcelain Tile

Bella SERIES
Marmi

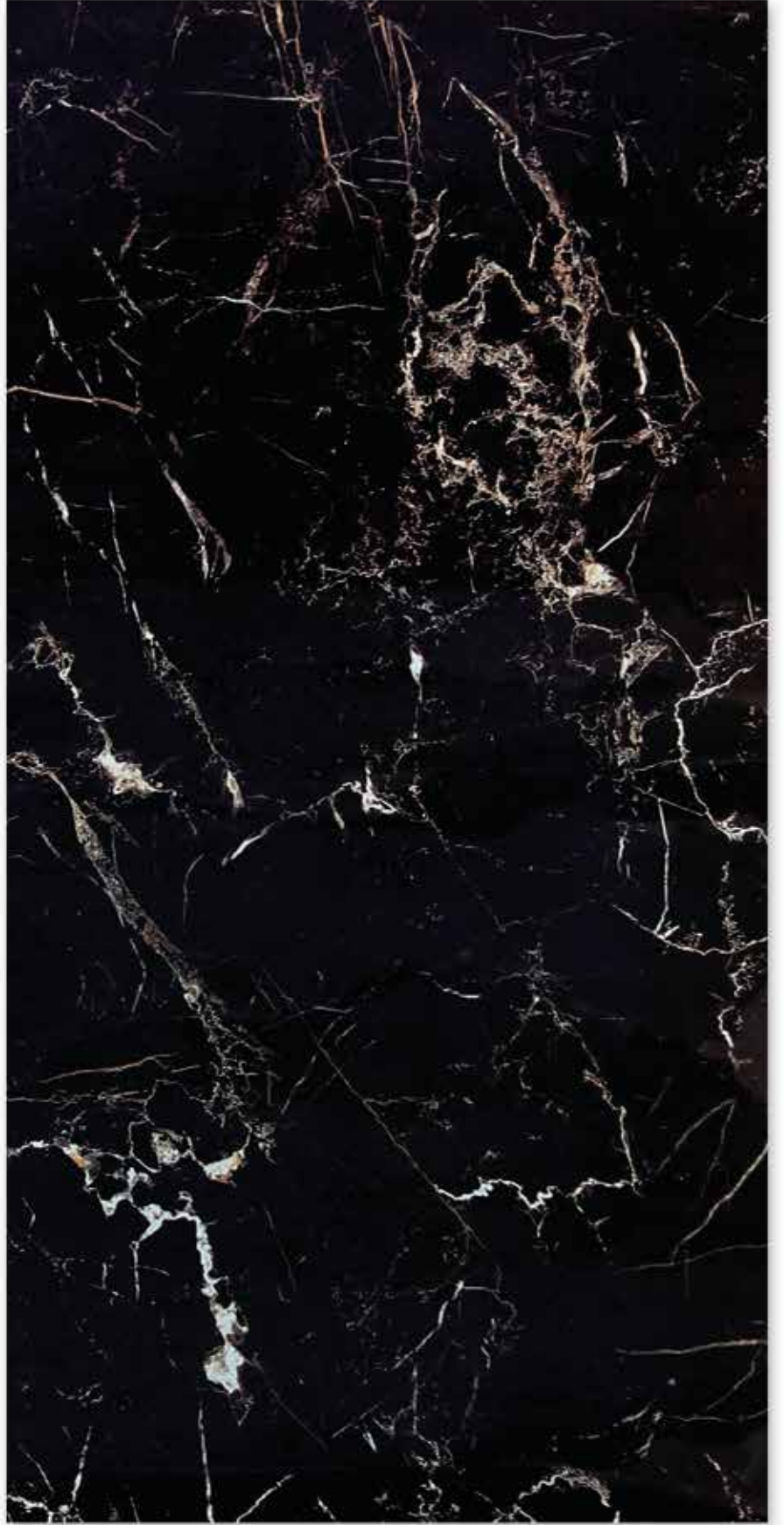

120x120cm 48"x48"

60x120cm 24"x48"
913910

60x60cm 24"x24"

PEL
2

Ürün / Product	Ebat / Size (cm)	Birim / Unit (m ² /Ad/kg)	Kutu / Box			Palet / Pallet		
			(Ad-Pcs)	(m ²)	(kg)	(Kutu-Box)	(m ²)	(kg)
Porselen Karo / Porcelain Tiles	120x120							
	60x120	m ²	2	1,44	36,3	29	41,76	1,080
	60x60	m ²	4	1,44	33	30	43,2	1,020



EMPERADOR

SİYAH/ BLACK

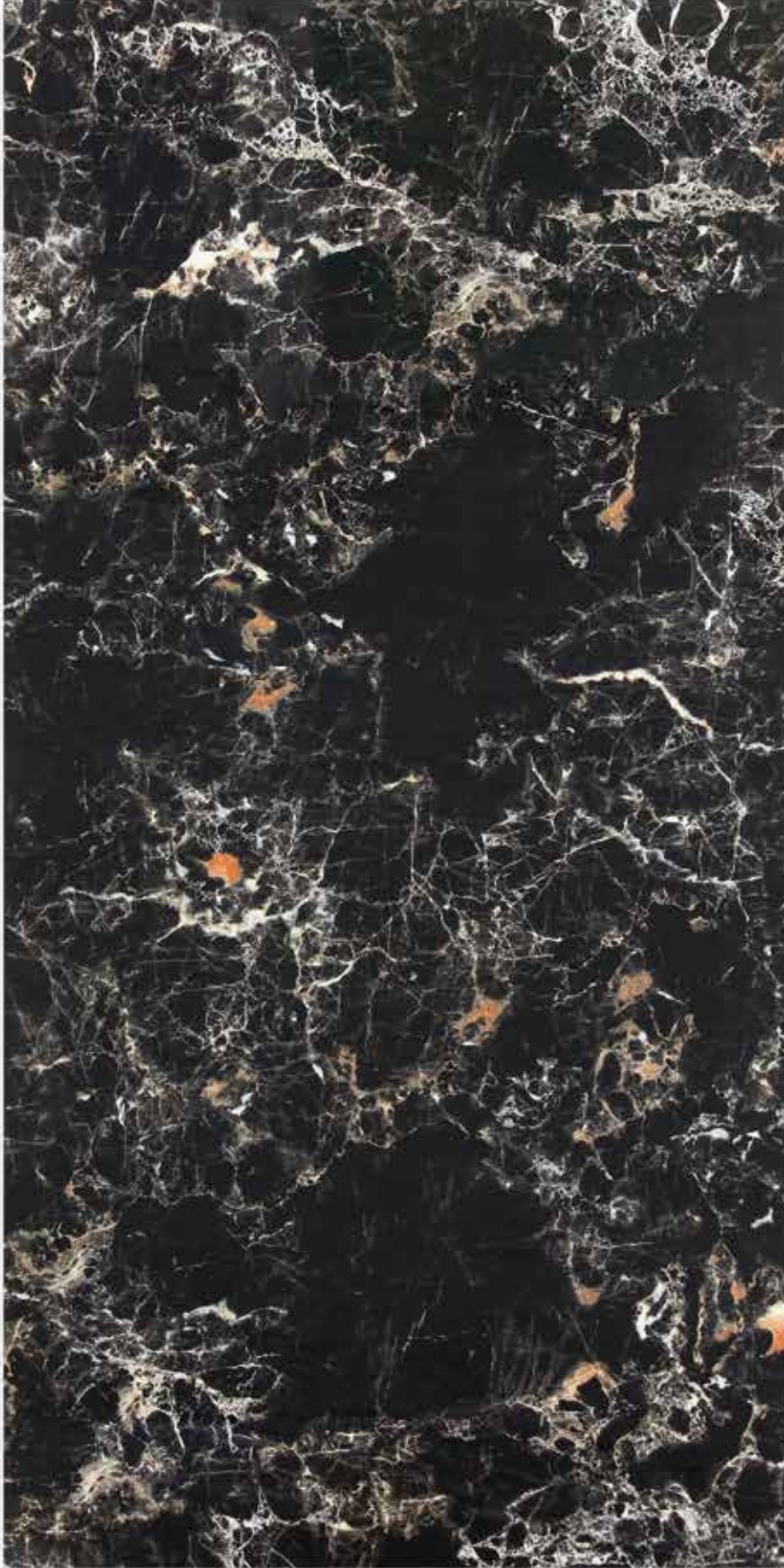

IGI ART

Sırlı Porselen Karo
Glazed Porcelain Tile

Bella SERIES
Marmi



120x120cm 48"x48"

60x120cm 24"x48"
496982

60x60cm 24"x24"

VERDE ALPI



DIGIART

Sırlı Porselen Karo
Glazed Porcelain Tile

Bella SERIES
Marmi



120x120cm 48"x48"

60x120cm 24"x48"
916910

60x60cm 24"x24"

BEL
2

Ürün / Product	Ebat / Size (cm)	Birim / Unit (m ² /Ad/kg)	Kutu / Box			Palet / Pallet		
			(Ad-Pcs)	(m ²)	(kg)	(Kutu-Box)	(m ²)	(kg)
Porselen Karo / Porcelain Tiles	120x120							
	60x120	m ²	2	1,44	36,3	29	41,76	1,080
	60x60	m ²	4	1,44	33	30	43,2	1,020



IGI ART

Sırlı Porselen Karo
Glazed Porcelain Tile

Bella SERIES
Marmi

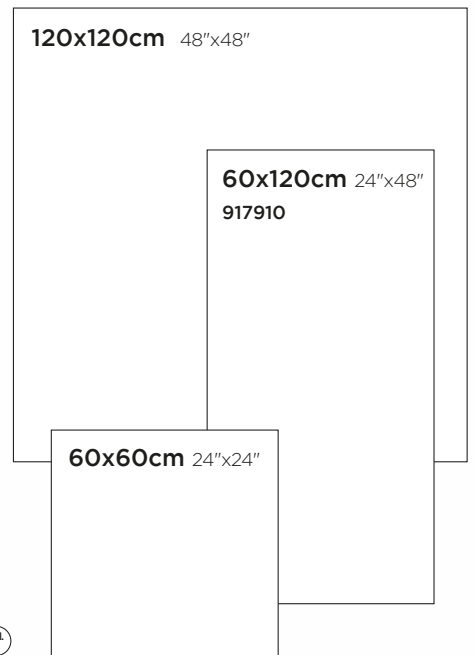
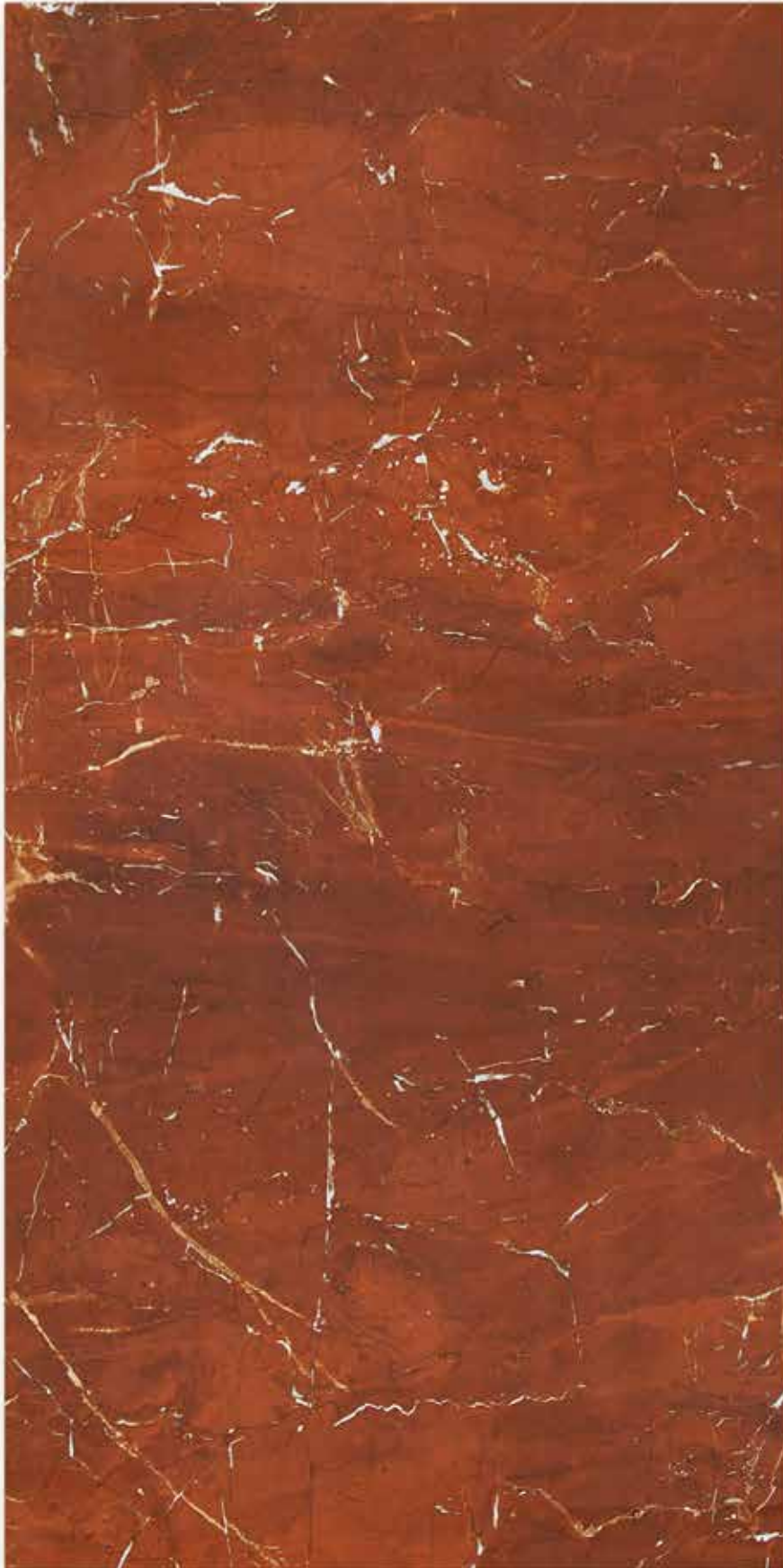

EPHESUS



IGI ART

Sırlı Porselen Karo
Glazed Porcelain Tile

Bella SERIES
Marmi



120x120cm 48"x48"

60x120cm 24"x48"
915910

60x60cm 24"x24"

BEL
3

Ürün / Product	Ebat / Size (cm)	Birim / Unit (m ² /Ad/kg)	Kutu / Box			Palet / Pallet		
			(Ad-Pcs)	(m ²)	(kg)	(Kutu-Box)	(m ²)	(kg)
Porselen Karo / Porcelain Tiles	120x120							
	60x120	m ²	2	1,44	36,3	29	41,76	1,080
	60x60	m ²	4	1,44	33	30	43,2	1,020



IGI ART

Sırlı Porselen Karo
Glazed Porcelain Tile

Bella SERIES
Marmi

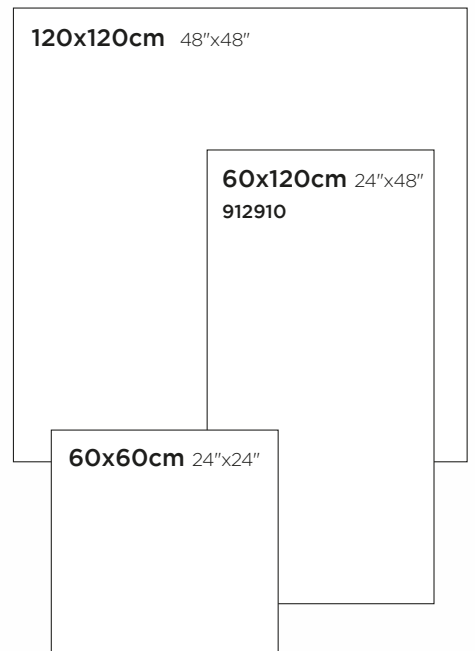

CASTELO



IGI ART

Sırlı Porselen Karo
Glazed Porcelain Tile

Bella SERIES
Marmi



120x120cm 48"x48"

60x120cm 24"x48"
914910

60x60cm 24"x24"

PEL
3

Ürün / Product	Ebat / Size (cm)	Birim / Unit (m ² /Ad/kg)	Kutu / Box			Palet / Pallet		
			(Ad-Pcs)	(m ²)	(kg)	(Kutu-Box)	(m ²)	(kg)
Porselen Karo / Porcelain Tiles	120x120							
	60x120	m ²	2	1,44	36,3	29	41,76	1,080
	60x60	m ²	4	1,44	33	30	43,2	1,020

TIVOLI DARK



IGI ART

Sırlı Porselen Karo
Glazed Porcelain Tile

Bella SERIES
Marmi

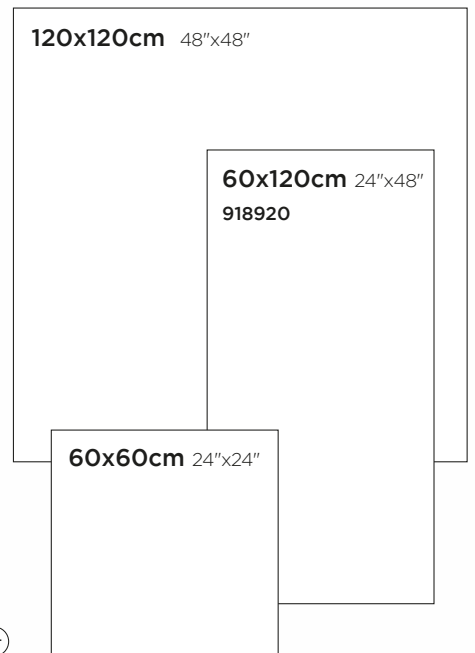

TIVOLI LIGHT



DIGIART

Sırlı Porselen Karo
Glazed Porcelain Tile

Bella SERIES
Marmi



120x120cm 48"x48"

60x120cm 24"x48"
918910

60x60cm 24"x24"

PEL
3

Ürün / Product	Ebat / Size (cm)	Birim / Unit (m ² /Ad/kg)	Kutu / Box			Palet / Pallet		
			(Ad-Pcs)	(m ²)	(kg)	(Kutu-Box)	(m ²)	(kg)
Porselen Karo / Porcelain Tiles	120x120							
	60x120	m ²	2	1,44	36,3	29	41,76	1,080
	60x60	m ²	4	1,44	33	30	43,2	1,020



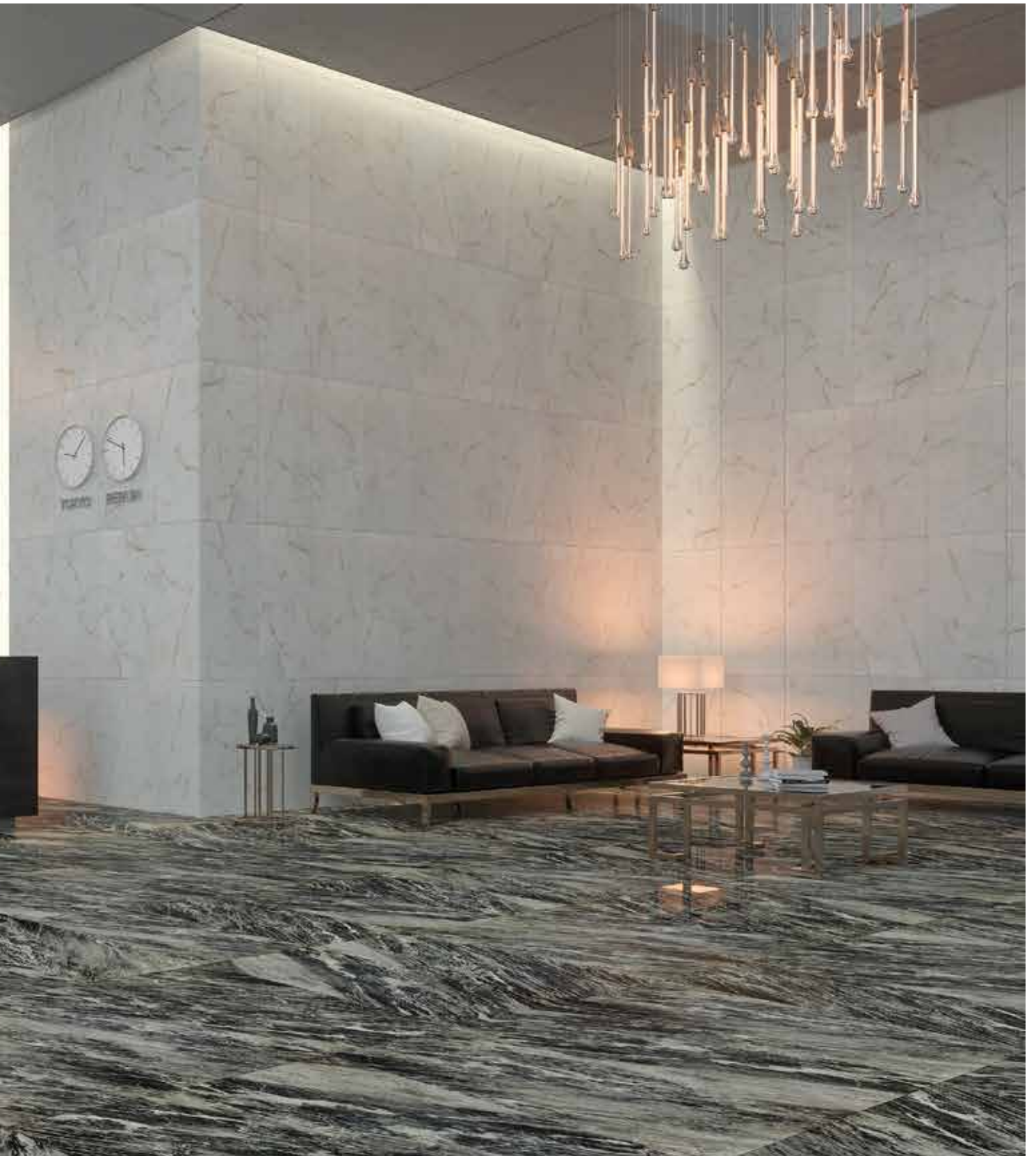



IGI ART

Sırlı Porselen Karo
Glazed Porcelain Tile



60x120cm 24"x48"
231901



NEW ORLEANS

BEYAZ / WHITE



IGI ART

Sırlı Porselen Karo
Glazed Porcelain Tile



120x120cm 48"x48"

60x120cm 24"x48"

205980 (M) (REL 4)

205920 (FL) (REL 3)

60x60cm 24"x24"

205971 (M) (REL 4)

205901 (FL) (REL 3)

Ürün / Product	Ebat / Size (cm)	Birim / Unit (m ² /Ad/kg)	Kutu / Box			Palet / Pallet		
			(Ad-Pcs)	(m ²)	(kg)	(Kutu-Box)	(m ²)	(kg)
Porselen Karo / Porcelain Tiles	120x120							
	60x120	m ²	2	1,44	36,3	29	41,76	1,080
	60x60	m ²	4	1,44	33	30	43,2	1,020



IGI ART

Sırlı Porselen Karo
Glazed Porcelain Tile

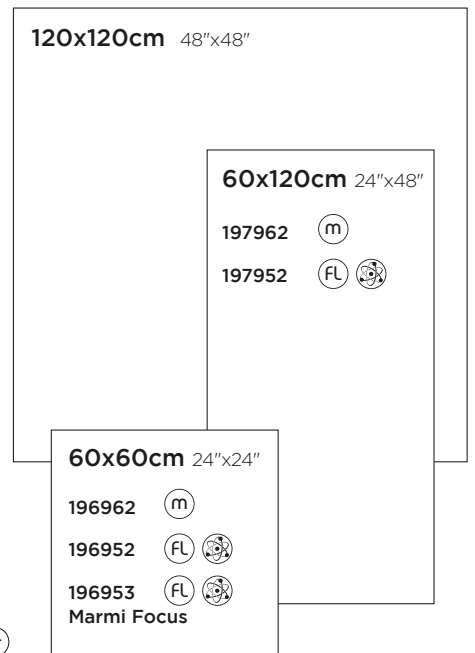

CALACATA MARMİ



MARMİ FOCUS

Ürün / Product	Ebat / Size (cm)	Birim / Unit (m ² /Ad/kg)	Kutu / Box			Palet / Pallet		
			(Ad-Pcs)	(m ²)	(kg)	(Kutu-Box)	(m ²)	(kg)
Porselen Karo / Porcelain Tiles	120x120							
	60x120	m ²	2	1,44	36,3	29	41,76	1,080
	60x60	m ²	4	1,44	33	30	43,2	1,020



MILANO
BEYAZ / WHITE



IGI ART

Sırsız Porselen Karo
Unglazed Porcelain Tile

- NanoTech Granitler, TS-EN 14411 standardına göre aşınma < 175 mm³ değerine uygun olarak üretilir.
- Abrasion resistance value of Nanotech granites is < 175 mm³ according to TS-EN 14411.

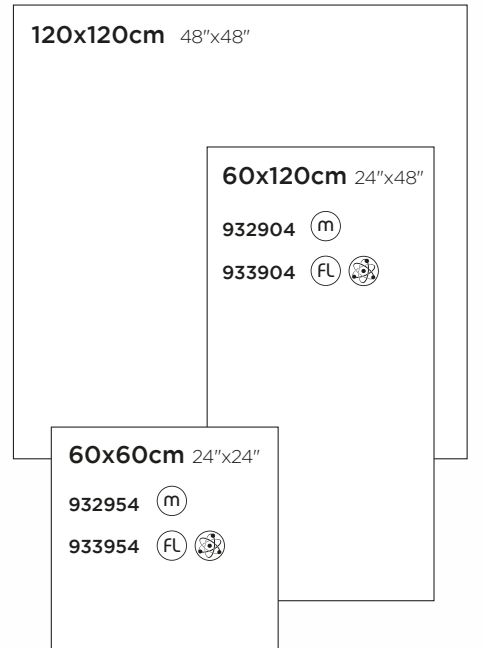

MILANO

GRİ / GREY



DIGIART

Sırsız Porselen Karo
Unglazed Porcelain Tile

- NanoTech Granitler, TS-EN 14411 standardına göre aşınma < 175 mm³ değerine uygun olarak üretilir.
- Abrasion resistance value of Nanotech granites is < 175 mm³ according to TS-EN 14411.

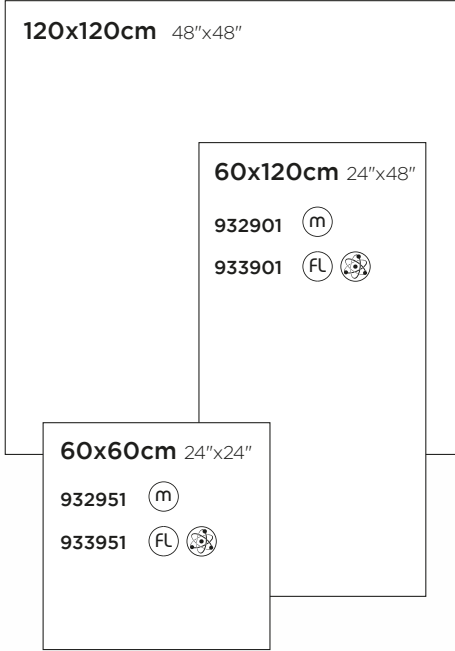

Ürün / Product	Ebat / Size (cm)	Birim / Unit (m ² /Ad/kg)	Kutu / Box			Palet / Pallet		
			(Ad-Pcs)	(m ²)	(kg)	(Kutu-Box)	(m ²)	(kg)
Porselen Karo / Porcelain Tiles	120x120							
	60x120	m ²	2	1,44	36,3	29	41,76	1,080
	60x60	m ²	4	1,44	33	30	43,2	1,020



MILANO
BEJ / BEIGE



IGI ART

Sırsız Porselen Karo
Unglazed Porcelain Tile

- NanoTech Granitler, TS-EN 14411 standardına göre aşınma < 175 mm³ değerine uygun olarak üretilir.
- Abrasion resistance value of Nanotech granites is < 175 mm³ according to TS-EN 14411.

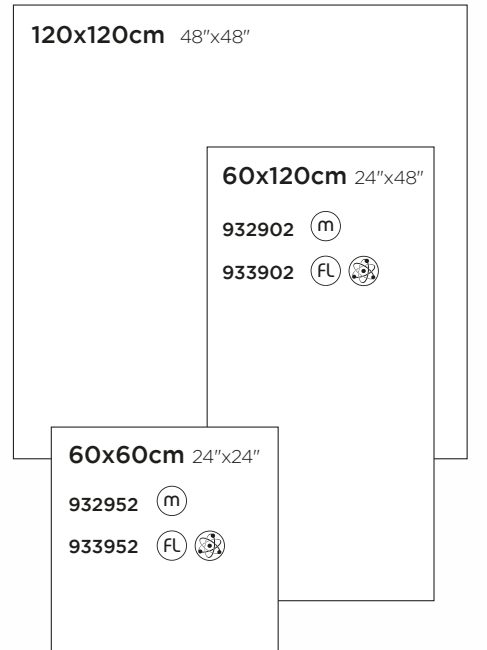

MILANO

SİYAH / BLACK



IGI ART

Sırsız Porselen Karo
Unglazed Porcelain Tile

- NanoTech Granitler, TS-EN 14411 standardına göre aşınma < 175 mm³ değerine uygun olarak üretilir.
- Abrasion resistance value of Nanotech granites is < 175 mm³ according to TS-EN 14411.

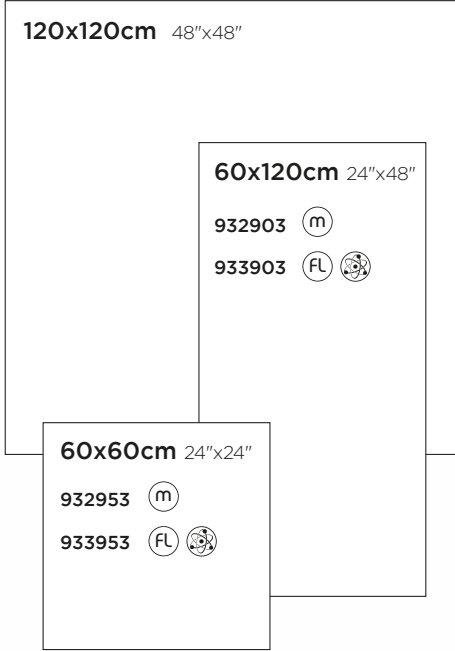
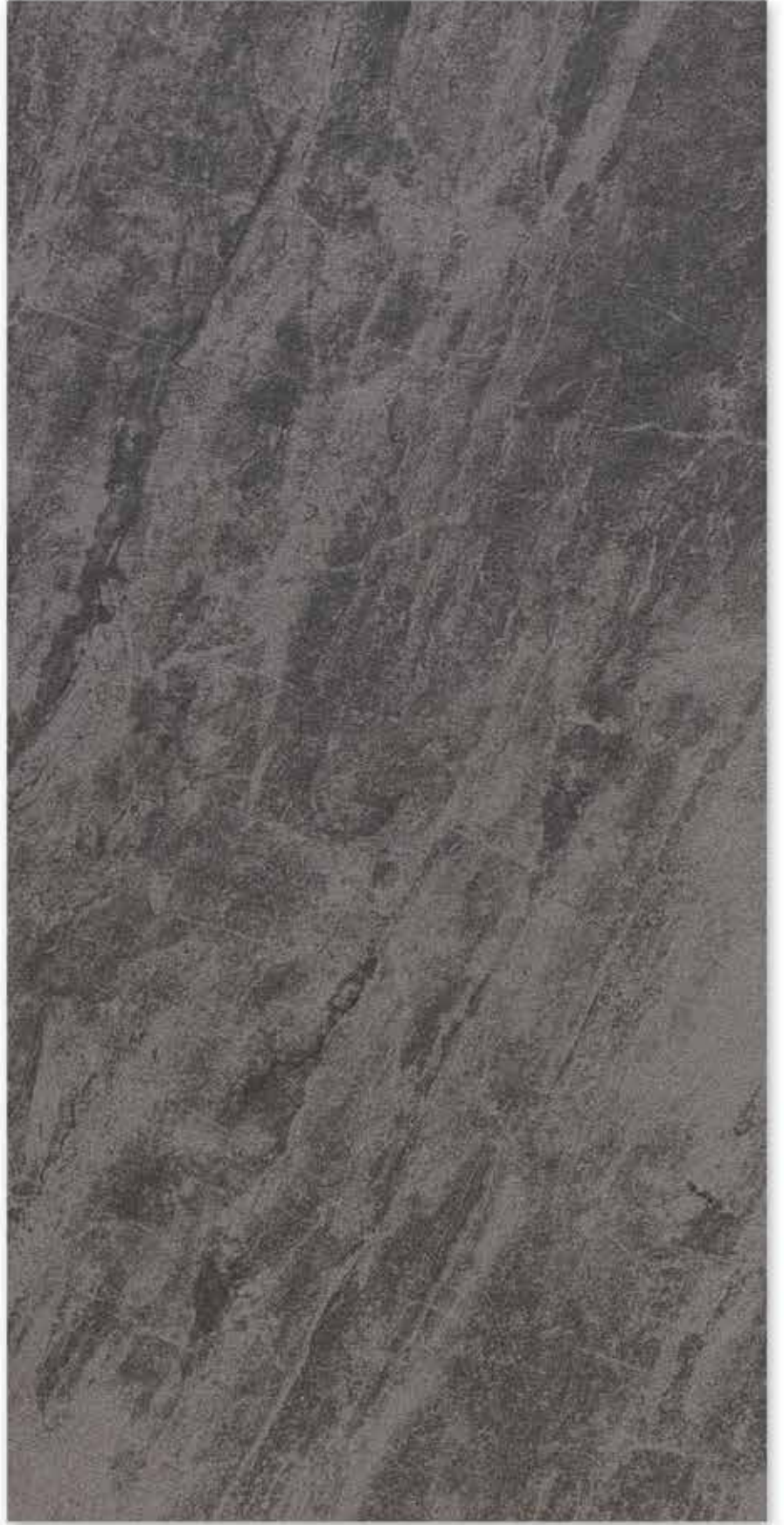

Ürün / Product	Ebat / Size (cm)	Birim / Unit (m ² /Ad/kg)	Kutu / Box			Palet / Pallet		
			(Ad-Pcs)	(m ²)	(kg)	(Kutu-Box)	(m ²)	(kg)
Porselen Karo / Porcelain Tiles	120x120							
	60x120	m ²	2	1,44	36,3	29	41,76	1,080
	60x60	m ²	4	1,44	33	30	43,2	1,020



PHILADELPHIA

GRİ / GREY



IGI ART

Sırlı Porselen Karo
Glazed Porcelain Tile



60x120cm 24"x48"
935904



PHILADELPHIA

KAHVE / BROWN



DIGIART

Sırlı Porselen Karo
Glazed Porcelain Tile



60x120cm 24"x48"
935901

PEL
2



Ürün / Product	Ebat / Size (cm)	Birim / Unit (m ² /Ad/kg)	Kutu / Box			Palet / Pallet		
			(Ad-Pcs)	(m ²)	(kg)	(Kutu-Box)	(m ²)	(kg)
Porselen Karo / Porcelain Tiles	60x120	m ²	2	1,44	36,3	29	41,76	1,080



PERGE
KREM / CREMA



DIGIART

Sırlı Porselen Karo
Glazed Porcelain Tile

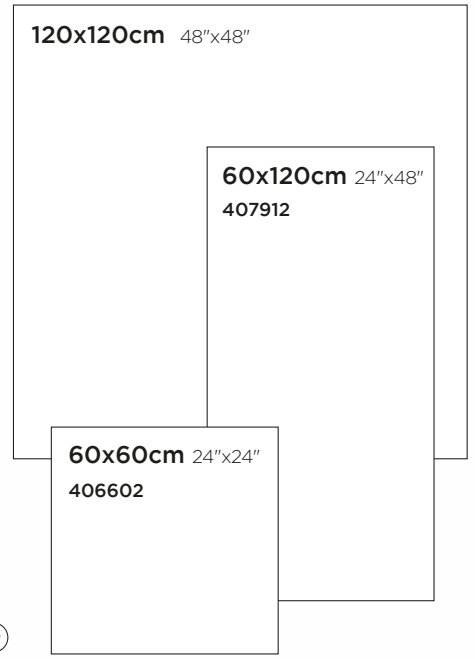

PERGE

BEJ / BEIGE



IGI ART

Sırlı Porselen Karo
Glazed Porcelain Tile



120x120cm 48"x48"

60x120cm 24"x48"
407911

60x60cm 24"x24"
406601

PEL
3

Ürün / Product	Ebat / Size (cm)	Birim / Unit (m ² /Ad/kg)	Kutu / Box			Palet / Pallet		
			(Ad-Pcs)	(m ²)	(kg)	(Kutu-Box)	(m ²)	(kg)
Porselen Karo / Porcelain Tiles	120x120							
	60x120	m ²	2	1,44	36,3	29	41,76	1,080
	60x60	m ²	4	1,44	33	30	43,2	1,020



PERGE

KAHVE / BROWN



IGI ART

Sırlı Porselen Karo
Glazed Porcelain Tile

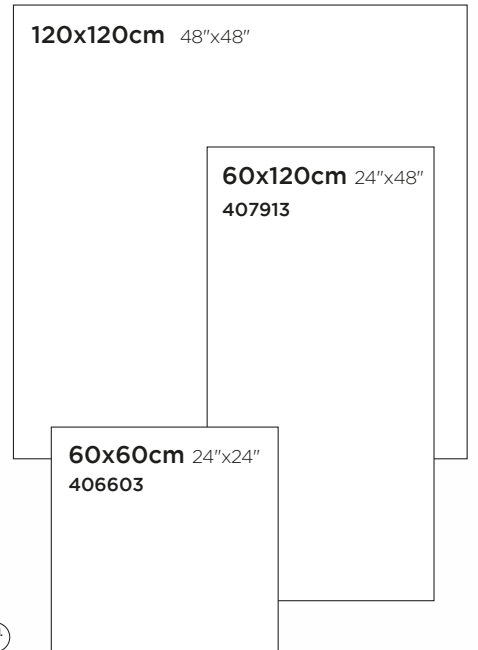

PARADISE

FLORA



IGI ART

Sırlı Porselen Karo
Glazed Porcelain Tile

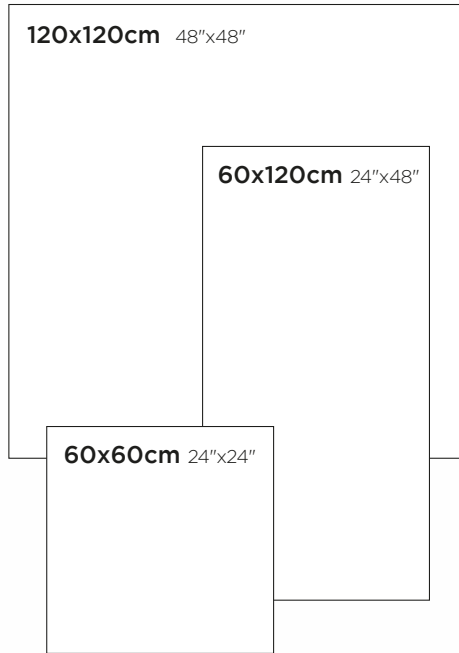

Ürün / Product	Ebat / Size (cm)	Birim / Unit (m ² /Ad/kg)	Kutu / Box			Palet / Pallet		
			(Ad-Pcs)	(m ²)	(kg)	(Kutu-Box)	(m ²)	(kg)
Porselen Karo / Porcelain Tiles	120x120							
	60x120	m ²	2	1,44	36,3	29	41,76	1,080
	60x60	m ²	4	1,44	33	30	43,2	1,020



BRECHA
KEMİK / BONE

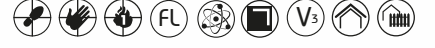

IGI ART

Sırlı Porselen Karo
Glazed Porcelain Tile



60x120cm 24"x48"
195901



GRANITO

SÜPER BEYAZ / SUPER WHITE



IGI ART

Sırsız Porselen Karo
Unglazed Porcelain Tile

- NanoTech Granitler, TS-EN 14411 standardına göre aşınma < 175 mm³ değerine uygun olarak üretilir.
- Abrasion resistance value of Nanotech granites is < 175 mm³ according to TS-EN 14411.

60x120cm 24"x48"
924951

Ürün / Product	Ebat / Size (cm)	Birim / Unit (m ² /Ad/kg)	Kutu / Box			Palet / Pallet		
			(Ad-Pcs)	(m ²)	(kg)	(Kutu-Box)	(m ²)	(kg)
Porselen Karo / Porcelain Tiles	60x120	m ²	2	1,44	36,3	29	41,76	1,080



IGI ART

Sırsız Porselen Karo
Unglazed Porcelain Tile

60x120cm 24"x48"

930902 BEYAZ / WHITE

930901 BEJ / BEIGE

930905 COLD GRİ / COLD GREY

930904 COOL GRİ / COOL GREY

930903 KOYU GRİ / DARK GREY

930906 KAHVE / BROWN

930907 KOYU KAHVE / DARK BROWN

930908 SİYAH / BLACK

BEYAZ / WHITE

KRIPTON



- NanoTech Granitler, TS-EN 14411 standardına göre aşınma < 175 mm³ değerine uygun olarak üretilir.
- Abrasion resistance value of Nanotech granites is < 175 mm³ according to TS-EN 14411.

Ürün / Product	Ebat / Size (cm)	Birim / Unit (m ² /Ad/kg)	Kutu / Box			Palet / Pallet		
			(Ad-Pcs)	(m ²)	(kg)	(Kutu-Box)	(m ²)	(kg)
Porselen Karo / Porcelain Tiles	60x120	m ²	2	1,44	36,2	29	41,76	1,080



DIGIART

Sırsız Porselen Karo
Unglazed Porcelain Tile

60x120cm 24"x48"

931902 BEYAZ / WHITE

931901 BEJ / BEIGE

931903 DARK GRİ / DARK GREY

931904 WARM GRİ / WARM GREY

931905 SIYAH / BLACK

BEJ / BEIGE

VENUS



- NanoTech Granitler, TS-EN 14411 standardına göre aşınma < 175 mm³ değerine uygun olarak üretilir.
- Abrasion resistance value of Nanotech granites is < 175 mm³ according to TS-EN 14411.

Ürün / Product	Ebat / Size (cm)	Birim / Unit (m ² /Ad/kg)	Kutu / Box			Palet / Pallet		
			(Ad-Pcs)	(m ²)	(kg)	(Kutu-Box)	(m ²)	(kg)
Porselen Karo / Porcelain Tiles	60x120	m ²	2	1,44	36,2	29	41,76	1,080

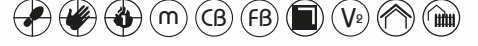

IGI ART

Sırsız Porselen Karo
Unglazed Porcelain Tile

120x120cm 48"x48"

228901 BEYAZ / WHITE

228903 AÇIK GRİ / LIGHT GREY

228904 GRİ / GREY

228902 SİYAH / BLACK

60x120cm 24"x48"

227901 BEYAZ / WHITE

227903 AÇIK GRİ / LIGHT GREY

227904 GRİ / GREY

227902 SİYAH / BLACK

60x60cm 24"x24"

226901 BEYAZ / WHITE

226903 AÇIK GRİ / LIGHT GREY

226904 GRİ / GREY

226902 SİYAH / BLACK

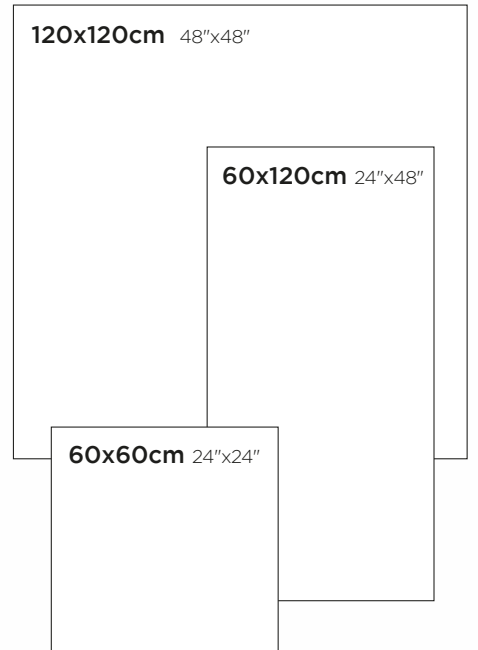

BEYAZ / WHITE

ISTANBUL

60x120cm 24"x48"



BEYAZ / WHITE



AÇIK GRİ / LIGHT GREY



GRİ / GREY



SİYAH / BLACK

60x60cm 24"x24"



BEYAZ / WHITE



AÇIK GRİ / LIGHT GREY



GRİ / GREY



SİYAH / BLACK

- NanoTech Granitler, TS-EN 14411 standardına göre aşınma < 175 mm³ değerine uygun olarak üretilir.
- Abrasion resistance value of Nanotech granites is < 175 mm³ according to TS-EN 14411.

Ürün / Product	Ebat / Size (cm)	Birim / Unit (m ² /Ad/kg)	Kutu / Box			Palet / Pallet		
			(Ad-Pcs)	(m ²)	(kg)	(Kutu-Box)	(m ²)	(kg)
Porselen Karo / Porcelain Tiles	120x120							
	60x120	m ²	2	1,44	36,3	29	41,76	1,080
	60x60	m ²	4	1,44	33	30	43,2	1,020

WOOD DREAM





WOOD DREAM

CEVİZ/ NOCE

DIGIART



Sırlı Porselen Karo Glazed Porcelain Tile

15x90cm 6"x36"



310934
CEVİZ / NOCE



311912
İMOLA CEVİZ MOTİF / İMOLA NOCE MOTİF



311922
TERNİ CEVİZ MOTİF / TERNİ NOCE MOTİF



311932
EMPOLİ CEVİZ MOTİF / EMPOLİ NOCE MOTİF



* Ürün fonu 7 farklı, motifler 4 farklı tasarımdan oluşur, bu nedenle kutular içerisinden farklı desenler çıkabilir.

* Since the product has 7 different faces and motifs have 4 different faces, you may receive different patterns in the boxes.

Ürün / Product	Ebat / Size (cm)	Birim / Unit (m ² /Ad/kg)	Kutu / Box			Palet / Pallet		
			(Ad-Pcs)	(m ²)	(kg)	(Kutu-Box)	(m ²)	(kg)
Porselen Karo / Porcelain Tiles	15x90	m ²	9	1,22	-	48	58,56	1,200



WOOD DREAM

AÇIK GRİ / LIGHT GREY

DIGIART



Sırlı Porselen Karo Glazed Porcelain Tile

15x90cm 6"x36"



310931
AÇIK GRİ / LIGHT GREY



311923
TERNİ AÇIK GRİ MOTİF / TERNI LIGHT GREY MOTIF



311933
EMPOLİ AÇIK GRİ MOTİF / EMPOLI LIGHT GREY MOTIF



* Ürün fonu 7 farklı, motifler 4 farklı tasarımdan oluşur, bu nedenle kutular içerisinde farklı desenler çıkabilir.

* Since the product has 7 different faces and motifs have 4 different faces, you may receive different patterns in the boxes.

Ürün / Product	Ebat / Size (cm)	Birim / Unit (m ² /Ad/kg)	Kutu / Box			Palet / Pallet		
			(Ad-Pcs)	(m ²)	(kg)	(Kutu-Box)	(m ²)	(kg)
Porselen Karo / Porcelain Tiles	15x90	m ²	9	1,22	-	48	58,56	1,200



WOOD DREAM

GRİ / GREY

DIGIART



Sırlı Porselen Karo Glazed Porcelain Tile

15x90cm 6"x36"



310932
GRİ / GREY



311914
İMOLA GRİ MOTİF / IMOLA GREY MOTIF



311924
TERNİ GRİ MOTİF / TERNİ GREY MOTIF



311934
EMPOLİ GRİ MOTİF / EMPOLİ GREY MOTIF



* Ürün fonu 7 farklı, motifler 4 farklı tasarımdan oluşur, bu nedenle kutular içerisinden farklı desenler çıkabilir.

* Since the product has 7 different faces and motifs have 4 different faces, you may receive different patterns in the boxes.

Ürün / Product	Ebat / Size (cm)	Birim / Unit (m ² /Ad/kg)	Kutu / Box			Palet / Pallet		
			(Ad-Pcs)	(m ²)	(kg)	(Kutu-Box)	(m ²)	(kg)
Porselen Karo / Porcelain Tiles	15x90	m ²	9	1,22	-	48	58,56	1,200



WOOD DREAM

BADEM / ALMOND

DIGIART



Sırlı Porselen Karo Glazed Porcelain Tile

15x90cm 6"x36"



310933
BADEM / ALMOND



311911
İMOLA BADEM MOTİF / İMOLA ALMOND MOTİF



311921
TERNİ BADEM MOTİF / TERNİ ALMOND MOTİF



311931
EMPOLİ BADEM MOTİF / EMPOLİ ALMOND MOTİF



* Ürün fonu 7 farklı, motifler 4 farklı tasarımdan oluşur, bu nedenle kutular içerisinde farklı desenler çıkabilir.

* Since the product has 7 different faces and motifs have 4 different faces, you may receive different patterns in the boxes.

Ürün / Product	Ebat / Size (cm)	Birim / Unit (m ² /Ad/kg)	Kutu / Box			Palet / Pallet		
			(Ad-Pcs)	(m ²)	(kg)	(Kutu-Box)	(m ²)	(kg)
Porselen Karo / Porcelain Tiles	15x90	m ²	9	1,22	-	48	58,56	1,200

315912
GRİ / GREY

315911
BEJ / BEIGE

315922
LACE GRİ MOTİF / LACE GREY MOTIF

315921
LACE BEJ MOTİF / LACE BEIGE MOTIF

* Ürün fonu 16 farklı, motifler 4 farklı tasarımdan oluşur, bu nedenle kutular içerisinde farklı desenler çıkabilir.

* Since the product has 16 different faces and motifs have 4 different faces, you may receive different patterns in the boxes.

Ürün / Product	Ebat / Size (cm)	Birim / Unit (m ² /Ad/kg)	Kutu / Box			Palet / Pallet		
			(Ad-Pcs)	(m ²)	(kg)	(Kutu-Box)	(m ²)	(kg)
Porselen Karo / Porcelain Tiles	15x90	m ²	9	1,22	-	48	58,56	1,200



MALMO
BEJ / BEIGE

DIGIART



Sırlı Porselen Karo / Glazed Porcelain Tile

15x90cm 6"x36"



312911
BEJ / BEIGE



314911
ENNA BEJ MOTİF / ENNA BEIGE MOTİF



313911
PONTE BEJ MOTİF / PONTE BEIGE MOTİF



* Ürün fonu 16 farklı, motifler 4 farklı tasarımdan oluşur, bu nedenle kutular içerisinde farklı desenler çıkabilir.

* Since the product has 16 different faces and motifs have 4 different faces, you may receive different patterns in the boxes.

Ürün / Product	Ebat / Size (cm)	Birim / Unit (m ² /Ad/kg)	Kutu / Box			Palet / Pallet		
			(Ad-Pcs)	(m ²)	(kg)	(Kutu-Box)	(m ²)	(kg)
Porselen Karo / Porcelain Tiles	15x90	m ²	9	1,22	-	48	58,56	1,200



MALMO

KAHVE / BROWN

DIGIART



Sırlı Porselen Karo Glazed Porcelain Tile

15x90cm 6"x36"



312910
KAHVE / BROWN



314910
ENNA KAHVE MOTİF / ENNA BROWN MOTİF



313910
PONTE KAHVE MOTİF / PONTE BROWN MOTİF



* Ürün fonu 16 farklı, motifler 4 farklı tasarımdan oluşur, bu nedenle kutular içerisinde farklı desenler çıkabilir.

* Since the product has 16 different faces and motifs have 4 different faces, you may receive different patterns in the boxes.

Ürün / Product	Ebat / Size (cm)	Birim / Unit (m ² /Ad/kg)	Kutu / Box			Palet / Pallet		
			(Ad-Pcs)	(m ²)	(kg)	(Kutu-Box)	(m ²)	(kg)
Porselen Karo / Porcelain Tiles	15x90	m ²	9	1,22	-	48	58,56	1,200



Sırlı Porselen Karo Glazed Porcelain Tile

15x90cm 6"x36"



312912
GRİ / GREY



* Ürün fonu 16 farklı, motifler 4 farklı tasarımdan oluşur, bu nedenle kutular içerisinden farklı desenler çıkabilir.

* Since the product has 16 different faces and motifs have 4 different faces, you may receive different patterns in the boxes.

Ürün / Product	Ebat / Size (cm)	Birim / Unit (m ² /Ad/kg)	Kutu / Box			Palet / Pallet		
			(Ad-Pcs)	(m ²)	(kg)	(Kutu-Box)	(m ²)	(kg)
Porselen Karo / Porcelain Tiles	15x90	m ²	9	1,22	-	48	58,56	1,200



Sırlı Porselen Karo Glazed Porcelain Tile

15x90cm 6"x36"



317912
GRI / GREY





317913
KIZIL / RED



* Ürün fonu 16 farklı tasarımdan oluşur, bu nedenle kutular içerisinde farklı desenler çıkabilir.
* Since the product has 16 different faces, you may receive different patterns in the boxes.

Ürün / Product	Ebat / Size (cm)	Birim / Unit (m ² /Ad/kg)	Kutu / Box			Palet / Pallet		
			(Ad-Pcs)	(m ²)	(kg)	(Kutu-Box)	(m ²)	(kg)
Porselen Karo / Porcelain Tiles	15x90	m ²	9	1,22	-	48	58,56	1,200



Sırlı Porselen Karo Glazed Porcelain Tile

15x90cm 6"x36"



31991
MAVI / BLUE



VISTA



31891
KAHVE / BROWN

* Ürün fonu 12 farklı tasarımdan oluşur, bu nedenle kutular içerisinde farklı desenler çıkabilir.
* Since the product has 12 different faces, you may receive different patterns in the boxes.

Ürün / Product	Ebat / Size (cm)	Birim / Unit (m ² /Ad/kg)	Kutu / Box			Palet / Pallet		
			(Ad-Pcs)	(m ²)	(kg)	(Kutu-Box)	(m ²)	(kg)
Porselen Karo / Porcelain Tiles	15x90	m ²	9	1,22	-	48	58,56	1,200



Sırlı Porselen Karo Glazed Porcelain Tile

15x90cm 6"x36"



316913
GRI / GREY



316912
BEJ / BEIGE



316911
NERO / NERO



Ürün / Product	Ebat / Size (cm)	Birim / Unit (m ² /Ad/kg)	Kutu / Box			Palet / Pallet		
			(Ad-Pcs)	(m ²)	(kg)	(Kutu-Box)	(m ²)	(kg)
Porselen Karo / Porcelain Tiles	15x90	m ²	9	1,22	-	48	58,56	1,200

AÇIK GRİ / LIGHT GREY

**CARPETTE AÇIK GRİ MOTİF
CARPETTE LIGHT GREY MOTIF**

230902 GRİ / GREY

**230912 CARPETTE GRİ MOTİF
CARPETTE GREY MOTIF**

230901 BEJ / BEIGE

**230911 CARPETTE BEJ MOTİF
CARPETTE BEIGE MOTIF**

* Ürün fonu ve motifler 4 farklı tasarımdan oluşur, bu nedenle kutular içerisinde farklı desenler çıkabilir.

* Since the product and motifs have 4 different faces, you may receive different patterns in the boxes.

Ürün / Product	Ebat / Size (cm)	Birim / Unit (m ² /Ad/kg)	Kutu / Box			Palet / Pallet		
			(Ad-Pcs)	(m ²)	(kg)	(Kutu-Box)	(m ²)	(kg)
Porselen Karo / Porcelain Tiles	60x60	m ²	4	1,44	33	30	43,2	1,020

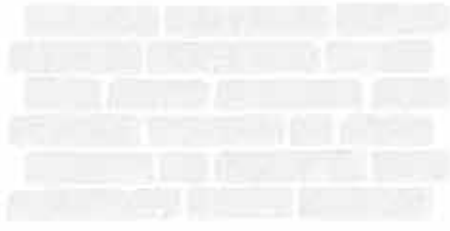

107905 BEYAZ / WHITE

PEL 3



107901 BEJ / BEIGE

PEL 3



107904 GRİ / GREY

PEL 2



107903 ANTRASİT / ANTRACIDE

PEL 2



107902 COTTO / COTTO

PEL 2

TRUVA



107951 BEJ / BEIGE

PEL 3



107954 GRİ / GREY

PEL 3



107952 KAHVE / BROWN

PEL 3

Ürün / Product	Ebat / Size (cm)	Birim / Unit (m ² /Ad/kg)	Kutu / Box			Palet / Pallet		
			(Ad-Pcs)	(m ²)	(kg)	(Kutu-Box)	(m ²)	(kg)
Porselen Karo / Porcelain Tiles	30x60	Ad	7	1,22	24,5	26	39	760



050501
BEYAZ / WHITE



050504
GRİ / GREY



050502
BEJ / BEIGE



* Ürün fonu 9 farklı tasarımdan oluşur, bu nedenle kutular içerisinde farklı desenler çıkabilir.
* Since the product has 9 different faces, you may receive different patterns in the boxes.

Ürün / Product	Ebat / Size (cm)	Birim / Unit (m ² /Ad/kg)	Kutu / Box			Palet / Pallet		
			(Ad-Pcs)	(m ²)	(kg)	(Kutu-Box)	(m ²)	(kg)
Porselen Karo / Porcelain Tiles	50x50	m ²	6	1,5	29,25	26	39	760



Sırlı Porselen Karo Glazed Porcelain Tile

50x50cm 20"x20"



310504
GRİ / GREY



310501
BEJ / BEIGE



* Ürün fonu 9 farklı tasarımdan oluşur, bu nedenle kutular içerisinde farklı desenler çıkabilir.
* Since the product has 9 different faces, you may receive different patterns in the boxes.

OLIMPOS



Sırlı Porselen Karo Glazed Porcelain Tile

50x50cm 20"x20"



497502
AÇIK GRİ / LIGHT GREY



497501
GRİ / GREY



* Ürün fonu 7 farklı tasarımdan oluşur, bu nedenle kutular içerisinde farklı desenler çıkabilir.
* Since the product has 7 different faces, you may receive different patterns in the boxes.

Ürün / Product	Ebat / Size (cm)	Birim / Unit (m ² /Ad/kg)	Kutu / Box			Palet / Pallet		
			(Ad-Pcs)	(m ²)	(kg)	(Kutu-Box)	(m ²)	(kg)
Porselen Karo / Porcelain Tiles	50x50	m ²	6	1,5	29,25	26	39	760

30x60cm 12"x24"

50x50cm 20"x20"



545902
MOCCA / MOCCA



545901
KAHVE / BROWN



BMF324 (1)
PENNA KAHVE MOTİF
PENNA BROWN MOTIF



BMF324 (2)
PENNA KAHVE MOTİF
PENNA BROWN MOTIF



BMF320 (1)
ARTICLE MOCCA MOTİF
ARTICLE MOCCA MOTIF



BMF320 (2)
ARTICLE MOCCA MOTİF
ARTICLE MOCCA MOTIF



BMF325 (1)
PENNA MOCCA MOTİF
PENNA MOCCA MOTIF



BMF325 (2)
PENNA MOCCA MOTİF
PENNA MOCCA MOTIF



545502
MOCCA / MOCCA

Sırlı Porselen Karo
 Glazed Porcelain Tile

PEL 2



545501
KAHVE / BROWN

Sırlı Porselen Karo
 Glazed Porcelain Tile

PEL 2

* Duvarlar 14 farklı tasarımdan oluşur, bu nedenle kutular içerisinde farklı desenler çıkabilir.

* Since the wall tiles have 14 different faces, you may receive different patterns in the boxes.

* Yerler 10 farklı tasarımdan oluşur, bu nedenle kutular içerisinde farklı desenler çıkabilir.

* Since the floor tiles have 10 different faces, you may receive different patterns in the boxes.

30x60cm 12"x24"

50x50cm 20"x20"



545904
AÇIK GRİ / LIGHT GREY



545903
GRİ / GREY



BMF321 (1)
ARTICLE AÇIK GRİ MOTİF
ARTICLE LIGHT GREY MOTIF



BMF321 (2)
ARTICLE AÇIK GRİ MOTİF
ARTICLE LIGHT GREY MOTIF



BMF326 (1)
PENNA AÇIK GRİ MOTİF
PENNA LIGHT GREY MOTIF



BMF326 (2)
PENNA AÇIK GRİ MOTİF
PENNA LIGHT GREY MOTIF



545504
AÇIK GRİ
LIGHT GREY

Sırlı Porselen Karo
Glazed Porcelain Tile



545503
GRİ / GREY

Sırlı Porselen Karo
Glazed Porcelain Tile

Ürün / Product	Ebat / Size (cm)	Birim / Unit (m ² /Ad/kg)	Kutu / Box			Palet / Pallet		
			(Ad-Pcs)	(m ²)	(kg)	(Kutu-Box)	(m ²)	(kg)
Duvar Karo / Wall	30x60	m ²	8	1,44	15,6	36	51,84	820
Dekor / Decor	30x60	Ad	6	-	16	-	-	-
Porselen Karo / Porcelain Tiles	50x50	m ²	6	1,5	29,25	26	39	760



30x60cm 12"x24"

50x50cm 20"x20"

902903
GRİ / GREY

902904
AÇIK GRİ / LIGHT GREY

* Duvarlar 14 farklı tasarımdan oluşur, bu nedenle kutular içerisinde farklı desenler çıkabilir.
 * Since the wall tiles have 14 different faces, you may receive different patterns in the boxes.

902921
AFA MIX MOTİF
AFA MIX MOTIF

902912
LİNEN HAVRE GRİ MOTİF
LINEN HAVRE GREY MOTIF

498503
GRİ / GREY
Sırlı Porselen Karo
Glazed Porcelain Tile

498504
AÇIK GRİ / LIGHT GREY
Sırlı Porselen Karo
Glazed Porcelain Tile

* Yerler 10 farklı tasarımdan oluşur, bu nedenle kutular içerisinde farklı desenler çıkabilir.
 * Since the floor tiles have 10 different faces, you may receive different patterns in the boxes.

Ürün / Product	Ebat / Size (cm)	Birim / Unit (m ² /Ad/kg)	(Ad-Pcs)	Kutu / Box		Palet / Pallet		
				(m ²)	(kg)	(Kutu-Box)	(m ²)	(kg)
Duvar Karo / Wall	30x60	m ²	8	1,44	15,6	36	51,84	820
Porselen Karo / Porcelain Tiles	50x50	m ²	6	1,5	29,25	26	39	760

30x60cm 12"x24"

50x50cm 20"x20"

902902
KAHVE / BROWN

902901
BEJ / BEIGE

* Duvarlar 14 farklı tasarımdan oluşur, bu nedenle kutular içerisinde farklı desenler çıkabilir.
* Since the wall tiles have 14 different faces, you may receive different patterns in the boxes.

902921
AFA MIX MOTİF
AFA MIX MOTIF

902911
LINEN HAVRE BEJ MOTİF
LINEN HAVRE BEIGE MOTIF

498502
KAHVE / BROWN



498501
BEJ / BEIGE

* Yerler 10 farklı tasarımdan oluşur, bu nedenle kutular içerisinde farklı desenler çıkabilir.
* Since the floor tiles have 10 different faces, you may receive different patterns in the boxes.

Ürün / Product	Ebat / Size (cm)	Birim / Unit (m ² /Ad/kg)	(Ad-Pcs)	Kutu / Box		Palet / Pallet		
				(m ²)	(kg)	(Kutu-Box)	(m ²)	(kg)
Duvar Karo / Wall	30x60	m ²	8	1,44	15,6	36	51,84	820
Porselen Karo / Porcelain Tiles	50x50	m ²	6	1,5	29,25	26	39	760



Sırlı Porselen Karo Glazed Porcelain Tile

30x60cm 12"x24" **6x60cm** 2.4"x24"



BMF145
PARMA PLATİN
PARMA PLATİN



BRS315
PARMA PLATİN BORDÜR
PARMA PLATİN LISTELLO



BMF148
ALBA PLATİN
ALBA PLATİN



BRS318
ALBA PLATİN BORDÜR
ALBA PLATİN LISTELLO

Ürün / Product	Ebat / Size (cm)	Birim / Unit (m ² /Ad/kg)	Kutu / Box			Palet / Pallet		
			(Ad-Pcs)	(m ²)	(kg)	(Kutu-Box)	(m ²)	(kg)
Dekor / Decor	30x60	Ad	6	-	21	16	-	336
Bordür / Listello	6x60	Ad	20	-	11	40	-	480



800302 (m) 800301 (9)
BEYAZ / WHITE



800332 (m) 800331 (9)
AÇIK GRİ / LIGHT GREY



800322 (m) 800321 (9)
SİYAH / BLACK

SERENA AUTUMN MOTİF



800342 (m) 800341 (9)
AUTUMN (1)



800342 (m) 800341 (9)
AUTUMN (2)



800342 (m) 800341 (9)
AUTUMN (3)



800342 (m) 800341 (9)
AUTUMN (4)



800342 (m) 800341 (9)
AUTUMN (5)



800342 (m) 800341 (9)
AUTUMN (6)

* Autumn Motif 6 farklı tasarımdan oluşur, bu nedenle kutular içerisinde farklı desenler çıkabilir.

* Since the Autumn motif has 6 different faces, you may receive different patterns in the boxes.

Ürün / Product	Ebat / Size (cm)	Birim / Unit (m ² /Ad/kg)	Kutu / Box			Palet / Pallet		
			(Ad-Pcs)	(m ²)	(kg)	(Kutu-Box)	(m ²)	(kg)
Duvar / Wall	30x30	m ²	6	0,54	-	68	36,72	575
Motif / Motif	30x30	m ²	6	0,54	-	34	18,36	290



800302 (m) 800301 (9)
BEYAZ / WHITE



800332 (m) 800331 (9)
AÇIK GRİ / LIGHT GREY



800322 (m) 800321 (9)
SİYAH / BLACK

SERENA SPRING MOTİF



800312 (m) 800311 (9)
SPRING (1)



800312 (m) 800311 (9)
SPRING (2)



800312 (m) 800311 (9)
SPRING (3)



800312 (m) 800311 (9)
SPRING (4)



800312 (m) 800311 (9)
SPRING (5)



800312 (m) 800311 (9)
SPRING (6)

* Spring Motif 6 farklı tasarımdan oluşur, bu nedenle kutular içerisinde farklı desenler çıkabilir.
* Since the Spring motif has 6 different faces, you may receive different patterns in the boxes.

Ürün / Product	Ebat / Size (cm)	Birim / Unit (m ² /Ad/kg)	Kutu / Box			Palet / Pallet		
			(Ad-Pcs)	(m ²)	(kg)	(Kutu-Box)	(m ²)	(kg)
Duvar / Wall	30x30	m ²	6	0,54	-	68	36,72	575
Motif / Motif	30x30	m ²	6	0,54	-	34	18,36	290



SERENA ISTANBUL MOTIF

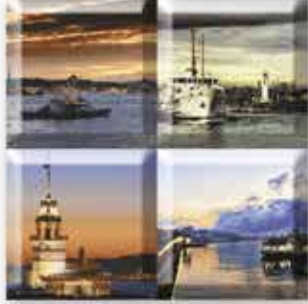

800352 (m) ISTANBUL (1)



800352 (m) ISTANBUL (2)



800352 (m) ISTANBUL (3)



800352 (m) ISTANBUL (4)



800352 (m) ISTANBUL (5)

* Istanbul motif 5 farklı tasarımdan oluşur, bu nedenle kutular içerisinde farklı desenler çıkabilir.

* Since the Istanbul motif has 5 different faces, you may receive different patterns in the boxes.

Ürün / Product	Ebat / Size (cm)	Birim / Unit (m ² /Ad/kg)	Kutu / Box			Palet / Pallet		
			(Ad-Pcs)	(m ²)	(kg)	(Kutu-Box)	(m ²)	(kg)
Duvar / Wall	30x30	m ²	6	0,54	-	68	36,72	575
Motif / Motif	30x30	m ²	6	0,54	-	34	18,36	290

TEKNİK BİLGİLER VE ÖZELLİKLER

TECHNICAL INFORMATION & CHARACTERISTICS

SEMBOLLER SYMBOLS



Yer Karosu
Floor Tile



Duvar Karosu
Wall Tile



Tek Pişirim
Single Firing



Çift Pişirim
Double Firing



Üç Pişirim
Third Firing



Parlak
Glossy



Mat
Matt



Lappato



Full
Lappato



High
Glossy



Naturel
Natural



Semi
Lappato



Nanotech



Renk Tonu Değişim
Color Shade Variation



Kaymazlık
Slipping Rate



Aşınmaya Dayanıklılık
Abrasion Resistance



Renkli Masse
Colored Body



Full Body



Rektifiyesiz
Unrectified



Rektifiyeli
Rectified



İç Mekan
Indoor



Dış Mekan
Outdoor



Yüzey Bitişi / Surface Treatments

High Glossy

Porselen karoların özel bir sır ile kaplanması ile elde edilen yüksek parlaklıktaki ürünlerdir.

They are highly lustrous porcelain tiles covered with a special glaze.

Mat / Matt

Yüzeyleri mat dokulu sır ile kaplanmış, yüzeyi işlem görmemiş karolardır.

They are natural tiles whose surfaces are glazed with matt glaze.

Parlak / Glossy

Yüzeyleri parlak dokulu sır ile kaplanmış, yüzeyi işlem görmemiş karolardır.

They are natural tiles whose surfaces are glazed with glossy glaze.

Lappato / Semi polished

Özel cam tanecikleri ile kaplanıp pişirilmiş karoların parlatılması ile elde edilen yarı parlak yarı mat yüzeylerdir.

They are semi-polished surfaces manufactured via the lustering of tiles after covering them with special glass grains/glass forming minerals then firing them.

Rölyef / Relief

Karoların şekillendirilmesi sırasında kalıplar vasıtası ile elde edilen yüzey dokularıdır.

They are the surface textures which are produced by moulds at the time of tile-sculpting.

Full Lappato

Özel sır ile kaplanmış karoların ince bir parlatma işlemine tabi tutulması ile elde edilen karolardır.

They are type of tiles produced by fine polishing of tiles covered with a special glaze.

Aşınmaya Dayanıklılık / Abrasion Resistance

P.E.I. - 1 Duvarlar ile banyo ve yatak odası zeminleri için uygundur. / Suitable for walls, bathroom and bedroom floors.

P.E.I. - 2 Konutlar gibi yaya trafiği az olan zeminler için uygundur. / Suitable for light traffic environments like the floor of a house.

P.E.I. - 3 Antre, koridor gibi giriş çıkışı fazla olan zeminler için uygundur. / Suitable for moderately heavy traffic area floors, like the entrance and the corridor.

P.E.I. - 4 Mağaza, restoran gibi yaya trafiğine daha fazla maruz kalan zeminler için uygundur. / Suitable for heavy traffic area floors like restaurants, shopping stores, etc.

P.E.I. - 5 Mağaza, otel, restoran, ofis, okul, teşhir salonu gibi yaya trafiğine fazla maruz kalan zeminler için uygundur. / Suitable for floors subject to heavy foot traffic and abrasion, such as shops, hotels, restaurants, offices, schools, exhibition halls, etc.

Renk Tonu Değişim Skalası / Color Shade Variation Guide

V1 DÜŞÜK

UNIFORM

Desen ve renk tonu farklılıkları düşük seviyededir.

The least amount of shade and texture variation attainable in naturally fired clay products.

V2 ORTA

SLIGHT

Desen ve renk tonu farklılıkları orta seviyededir.

Light to moderate shade and texture variation within each box.

V3 YÜKSEK

HIGH

Desen ve renk tonu farklılıkları yüksek seviyededir.

High shade and texture variation within each box.

V4 DEĞİŞKEN

RANDOM

Desen ve renk tonu farklılıkları en üst seviyededir.

Very high shade and texture variation within each box.

Kenar Bitişi / Edge Treatments

Rektifiyeli (Ebatlanmış) / Rectified

Karoların kenarlarının tıraşlanarak 1mm'den daha düşük sapma olacak şekilde aynı boyuta (tek kalibrasyona) getirilmesi işlemidir. Bu sayede ürünler daha küçük derz aralıkları ile döşenebilir ve görsel kalite artar.

It is the process of cutting the edges of tiles to same size with the deviation of less than 1 mm. As a result, these tiles can be laid with a narrower grout joint. Moreover, visual quality increases.

Pahlı / Chamfered

Karoların ebatlamadan sonra kenarlarındaki keskinliğin yuvarlatılması işlemidir. Bu sayede kullanıcıya verebileceği zarar engellenmiş olur. Aynı zamanda kenar kırılmaları da önlenir.

The process of rounding of the edges of tiles after the tile sizing. This process prevents damage to the user. At the same time it prevents edge breaks.



TEKNİK ÖZELLİKLER TECHNICAL CHARACTERISTICS

Duvar Karosu Teknik Özellikleri Wall Tiles Technical Characteristics

Teknik Özellikler / Technical Characteristics	Türk & Avrupa Standardı Turkish & European Standart (TS - EN 14411 BIII)	Seramiksan Sırlı & Sırsız Duvar Karoları Glazed & Unglazed Wall Tiles	TS - EN
Ebat Toleransı Uzunluk ve Genişlik / Deviations from Dimensions Length and Width (L=cm, S=cm ²)	l ≤ 12 cm ise ± 0.75 l > 12 cm ise ± 0.5	l ≤ 12 cm ise ± 0.75 l > 12 cm ise ± 0.5	ISO 10545 - 2
Ebat Toleransı Kalınlık / Deviations from Dimensions Thickness (%)	% 10	% 5	ISO 10545 - 2
Gönyeden Sapma / Rectangularity	Max. ± % 0.5	Max. ± % 0.3	ISO 10545 - 2
Kenar Düzgünlüğü / Straightness of Sides	Max. ± % 0.3	Max. ± % 0.3	ISO 10545 - 2
Yüzey Düzgünlüğü / Surface Flatness	+ % 0.5 - % 0.3	+% 0.5 - % 0.3	ISO 10545 - 2
Yüzey Kalitesi / Surface Quality	Max. % 5 Kusurlu / % 5 Defective	Uygundur / Affirmative	ISO 10545 - 2
Su Emme / Water Absorption	Ortalama %10, eğer %20'yi geçerse üretici tarafından belirtilecektir. Ave. > 10 %, when the value exceeds %20 this shall be indicated by the manufacturer.	Ort / Ave. %16	ISO 10545 - 3
Eğilme Dayanımı / Bending Strength (N/mm ²)	Kalınlık / Thickness < 7.5 mm.Min. 15 Kalınlık / Thickness > 7.5 mm.Min. 12	Min. 20	ISO 10545 - 4
Isı Genleşme Katsayısı / Linear Thermal Expansion Coefficient	Deney yöntemi mevcuttur. Test method available.	< 9x10 ⁻⁶ K ⁻¹	ISO 10545 - 8
Isı Şokuna Dayanıklılık / Resistance to Thermal Shock	Deney yöntemi mevcuttur. Test method available.	Uygundur / Affirmative	ISO 10545 - 9
Sırlı Karolarda Çatlama Dayanımı / Cracking Resistance in Glazed Tiles	İstenir / Required	Uygundur / Affirmative	ISO 10545 - 11
Asit ve Alkaliye Dayanıklılık Resistance to Acids and Alkalies	Deney yöntemi mevcuttur. Test method available.	Uygundur / Affirmative	ISO 10545 - 13
Evsel Temizlik Maddelerine ve Yüzme Havuzu Tuzlarına Dayanıklılık Resistance to Household Chemicals and Swimming Pool Salts	Min. GB	Min. GB	ISO 10545 - 13
Lekelenmeye Dayanıklılık / Resistance to Staining	Min. Sınıf 3 / Min. Class 3	Min. Sınıf 3 / Min. Class 3	ISO 10545 - 14

Yer Karosu Teknik Özellikleri Floor Tiles Technical Characteristics

Teknik Özellikler / Technical Characteristics	Türk & Avrupa Standardı Turkish & European Standart (TS - EN 14411 BIIb)	Seramiksan Sırlı Yer Karoları Glazed Floor Tiles	TS - EN
Ebat Toleransı Uzunluk ve Genişlik / Deviations from Dimensions Length and Width (L=cm, S=cm ²)	190<S<410 ise ± %0.75 S> 410 ise ± 0.5	± %0.5 (Tüm ebatlar için)	ISO 10545 - 2
Ebat Toleransı Kalınlık / Deviations from Dimensions Thickness (%)	± % 5	± % 5	ISO 10545 - 2
Gönyeden Sapma / Rectangularity	% 0.6	± % 0.4	ISO 10545 - 2
Kenar Düzgünlüğü / Straightness of Sides	± % 0.5	± % 0.3	ISO 10545 - 2
Yüzey Kalitesi / Surface Quality	Max. % 5 Kusurlu / % 5 Defective	Uygundur / Affirmative	ISO 10545 - 2
Düzlemden Sapma / Surface Flatness	± % 0.5	± % 0.3	ISO 10545 - 2
Su Emme Yer Karosu / Water Absorption Floor Tiles	Max. % 3	Max. % 3	ISO 10545 - 3
Eğilme Dayanımı Yer Karosu / Bending Strength Floor Tiles (N/mm ²)	Min. 30	Min. 35	ISO 10545 - 4
Aşınmaya Dayanıklılık Yer Karosu / Abrasion Resistance Floor Tiles	Üretici belirler	Katalog içerisinde beyan edilmiştir	ISO 10545 - 7
Isı Genleşme Katsayısı / Linear Thermal Expansion Coefficient	Deney yöntemi mevcuttur. Test method available.	< 9x10 ⁻⁶ K ⁻¹	ISO 10545 - 8
Isı Şokuna Dayanıklılık / Resistance to Thermal Shock	Deney yöntemi mevcuttur. Test method available.	Uygundur / Affirmative	ISO 10545 - 9
Çatlama Dayanımı / Cracking Resistance Tiles	İstenir/Required	Uygundur / Affirmative	ISO 10545 - 11
Asit ve Alkaliye Dayanıklılık Resistance to Acids and Alkalies	Deney yöntemi mevcuttur. Test method available.	Uygundur / Affirmative	ISO 10545 - 13
Evsel Temizlik Maddelerine ve Yüzme Havuzu Tuzlarına Dayanıklılık Sırlı Karolar Resistance to Household Chemicals and Swimming Pool Salts Glazed Tiles	Min. GB	Min. GB	ISO 10545 - 13
Evsel Temizlik Maddelerine ve Yüzme Havuzu Tuzlarına Dayanıklılık Sırsız Karolar Resistance to Household Chemicals and Swimming Pool Salts Unglazed Tiles	Min. UB	Min. UB	ISO 10545 - 13
Lekelenmeye Dayanıklılık / Resistance to Staining	Min. Sınıf 3 / Min. Class 3	Min. Sınıf 3 / Min. Class 3	ISO 10545 - 14

Porselen Karo Teknik Özellikleri

Porcelain Tiles Technical Characteristics

Teknik Özellikler / Technical Characteristics	Türk & Avrupa Standardı Turkish & European Standart (TS - EN 14411 Bla)	Seramiksın Sırlı & Sırsız Porselen Karolar Glazed & Unglazed Porcelain Tiles	TS - EN
Ebat Toleransı Uzunluk ve Genişlik Deviations from Dimensions Length and Width (L=cm, S=cm ²)	"190<S<410 ise %0.75 S> 410 ise 0.5"	%0.5 (Tüm ebatlar için)	ISO 10545 - 2
Ebat Toleransı Kalınlık / Deviations from Dimensions Thickness (%)	% 5	% 5	ISO 10545 - 2
Gönyeden Sapma / Rectangularity	% 5	% 0.4	ISO 10545 - 2
Kenar Düzgünlüğü / Straightness of Sides	% 6	% 0.3	ISO 10545 - 2
Yüzey Kalitesi / Surface Quality	Max. % 5 Kusurlu / % 5 Defective	Uygundur / Affirmative	ISO 10545 - 2
Düzlemden Sapma / Surface Flatness	% 0.5	% 0.3	ISO 10545 - 2
Su Emme Sırlı Porselen / Water Absorption Glazed Porcelain Tile	Max. % 0.5	Max. % 0.5	ISO 10545 - 3
Su Emme Sırsız Porselen / Water Absorption Unglazed Porcelain Tile	Max. % 0.5	Max. % 0.05	ISO 10545 - 3
Eğilme Dayanımı Sırlı Porselen Bending Strength Glazed Porcelain Tiles (N/mm ²)	35	40	ISO 10545 - 4
Eğilme Dayanımı Sırsız Porselen Bending Strength Unglazed Porcelain Tiles (N/mm ²)	35	45	ISO 10545 - 4
Aşınmaya Dayanıklılık Sırlı Porselen Abrasion Resistance Glazed Porcelain Tiles	Indicated by manufacturer	Indicated in the catalogue	ISO 10545 - 7
Aşınmaya Dayanıklılık Sırsız Porselen Abrasion Resistance Unglazed Porcelain Tiles	Max. 175 mm ³	Max. 175 mm ³	ISO 10545 - 7
Isıl Genleşme Katsayısı / Linear Thermal Expansion Coefficient	"Deney yöntemi mevcuttur. Test method available."	< 90x10 ⁻⁷ K ⁻¹	ISO 10545 - 8
Isı Şokuna Dayanıklılık / Resistance to Thermal Shock	"Deney yöntemi mevcuttur. Test method available."	Uygundur / Affirmative	ISO 10545 - 9
Çatlama Dayanımı / Cracking Resistance Tiles	İstenir/Required	Uygundur / Affirmative	ISO 10545 - 11
"Asit ve Alkaliye Dayanıklılık / Resistance to Acids and Alkalies"	"Deney yöntemi mevcuttur. Test method available."	Uygundur / Affirmative	ISO 10545 - 13
"Eysel Temizlik Maddelerine ve Yüzme Havuzu Tuzlarına Dayanıklılık Sırlı Karolar Resistance to Household Chemicals and Swimming Pool Salts Glazed Tiles"	Min. GB	Min. GB	ISO 10545 - 13
"Eysel Temizlik Maddelerine ve Yüzme Havuzu Tuzlarına Dayanıklılık Sırsız Karolar Resistance to Household Chemicals and Swimming Pool Salts Unglazed Tiles"	Min. UB	Min. UB	ISO 10545 - 13
Lekelemeye Dayanıklılık / Resistance to Staining	Min. Sınıf 3 / Min. Class 3	Min. Sınıf 3 / Min. Class 3	ISO 10545 - 14

Tablolarda belirtilen toplam palet ağırlıkları, üretim teknolojisi, kullanılan ambalaj malzemeleri ve paletlemeden kaynaklanan değişikliklerden dolayı farklılıklar arz edebilir.

* Teknik porselenlerde su emme <%0.05 ve aşınma değeri <175 mm³

Seramiklerin yanında görülen numaralar, Türk ve Avrupa Standardı TS-EN 10545-7'ye göre yüzey aşınma dayanım sınıfını belirler. The numbers beside ceramic tiles indicate the abrasion resistance of the ceramic surface according to Turkish and European Standart TS-EN 10545-7

Seramiksın, bu katalogta belirtilen ve hiç biri yasal olarak bağlayıcı olmayan bilgi ve teknik özellikleri, dilediği herhangi bir anda ve önceden haber vermeden değiştirme hakkını saklı tutar. Ağırlık, renk ve boyutlar, seramik fırınlama işleminden kaynaklanan normal sınırlar içinde değişiklik gösterebilir. Katalogumuzda belirtilen renkler ürünlerimizin gerçek renklerini yansıtmayabilir.

Seramiksın, reserves the right at any time and without prior notice to change the information and technical characteristics given in this catalog, none of which are to be considered legally binding. Weights, colors and dimensions are subjects to the normal variations resulting from the ceramic firing process. The colors that are seen in our catalog may not reflect the original colours of our products.

BÖLGE SATIŞ YÖNETİCİLERİ

MARMARA BÖLGE VİTRİFİYE SATIŞ YÖNETİCİSİ

Tel: 0549 791 48 65

SAMSUN BÖLGE VİTRİFİYE SATIŞ YÖNETİCİSİ

Tel: 0549 727 23 64

İZMİR BÖLGE VİTRİFİYE SATIŞ YÖNETİCİSİ

Tel: 0533 129 82 18

ANKARA BÖLGE VİTRİFİYE SATIŞ YÖNETİCİSİ

Tel: 0533 594 66 40

ADANA BÖLGE VİTRİFİYE SATIŞ YÖNETİCİSİ

Tel: 0533 705 73 38

İZMİR I BÖLGE (Aydın, Denizli, İzmir, Manisa)

Tel: 0533 594 66 35

İZMİR II BÖLGE (Balıkesir, İzmir)

Tel: 0533 594 66 52

İZMİR III BÖLGE (İzmir, Manisa)

Tel: 0530 310 95 57

İZMİR IV BÖLGE (İzmir, Muğla)

Tel: 0533 594 66 53

İSTANBUL (AVRUPA) BÖLGE (Edirne, İstanbul(Avrupa), Kırklareli, Tekirdağ)

Tel: 0533 594 66 56

İSTANBUL (ANADOLU) BÖLGE (Bartın, Bolu, Düzce, İstanbul (Anadolu),

Karabük, Sakarya, Zonguldak)

Tel: 0533 594 66 58

BURSA I BÖLGE (Balıkesir, Bursa, Çanakkale)

Tel: 0533 594 66 55

BURSA II BÖLGE (Bursa, Bilecik, Yalova, Eskişehir, Kütahya, Uşak)

Tel: 0533 129 82 19

KONYA / ANTALYA BÖLGE (Afyon, Karaman, Konya, Uşak, Antalya, Burdur, Isparta)

Tel: 0533 129 82 19

ANKARA BÖLGE (Ankara, Çankırı, Kayseri, Kırıkkale, Kırşehir, Nevşehir)

Tel: 0533 594 66 48

ADANA BÖLGE (Adana, Antakya, Mersin, Osmaniye, Niğde, Aksaray)

Tel: 0533 594 66 41

GAZİANTEP BÖLGE (Gaziantep, Adıyaman, Kahramanmaraş, Malatya, Elazığ, Tunceli, Kilis)

Tel: 0533 594 66 44

SAMSUN BÖLGE (Amasya, Çorum, Giresun, Kastamonu, Samsun, Sinop, Ordu, Tokat, Sivas, Yozgat)

Tel: 0533 594 66 45

TRABZON BÖLGE (Artvin, Bayburt, Gümüşhane, Rize, Trabzon)

Tel: 0533 594 66 47

DİYARBAKIR BÖLGE (Diyarbakır, Batman, Bingöl, Bitlis, Hakkari, Mardin, Muş,

Siirt, Şanlıurfa, Şırnak, Van)

Tel: 0533 594 66 54

ERZURUM BÖLGE (Ardahan, Kars, Ağrı, Erzurum, Iğdır, Erzincan)

Tel: 0530 063 67 75

Kurumsal Müşteri ve Projeler Yöneticisi

Tel: 0533 594 66 59

Yapı Marketler Satış Yöneticisi

Tel: 0549 791 48 66



Fabrika / Factory
Organize Sanayi Bölgesi,
45401 Turgutlu-MANİSA/TÜRKİYE
T : +90 (236) 313 9613
F : +90 (236) 313 7764

info@seramiksan.com.tr export@seramiksan.com.tr
seramiksan.com.tr seracad.com

www.grafisreklam.com.tr 03/17



facebook.com/
seramiksan



twitter.com/
seramiksan



instagram.com/
seramiksan

